

Dialog⁺® Dialysis Machine

Instructions for Use SW 9.1x



CE 0123

CE marking according to directive 93/42/EEC
Technical alterations reserved

Rx only

RTD.IM01 04/05

IFU 38910363US / Rev. 2.15.10 / May 2016

B | BRAUN
SHARING EXPERTISE

Manufacturer:

B. Braun Avitum AG

34209 Melsungen, Germany

Tel +49 (56 61) 71-3716

Fax +49 (56 61) 75-3716

US Distributor:

B. Braun Medical Inc.

Avitum Division

Bethlehem, PA 18018-3524, USA

Made in Germany

Tel 1-800-621-0445

Fax (610) 691-1547

1	Safe handling	1
2	Product description	2
3	Installation and commissioning	3
4	Therapy types	4
5	Preparing for hemodialysis	5
6	Initiating hemodialysis	6
7	Ending hemodialysis therapy	7
8	Disinfection	8
9	Single-needle procedure	9
10	Use of options	10
11	Configuration	11
12	Maintenance and cleaning	12
13	Alarms and remedial action	13
14	Accessories	14
15	Technical data	15
16	Appendix	16

Table of contents

1	Safe handling	1-3
1.1	Intended use and indications	1-3
1.2	Contraindications	1-3
1.3	Side effects	1-3
1.4	About these Instructions for Use.....	1-4
1.4.1	Applicability.....	1-4
1.4.2	Target group	1-4
1.4.3	Warnings, notices and symbols in these Instructions for Use	1-4
1.4.4	Abbreviations	1-6
1.5	Special hazards and precautions.....	1-6
1.5.1	Special patient conditions.....	1-6
1.5.2	Electrical hazards.....	1-7
1.5.3	Electromagnetic interaction	1-7
1.5.4	Maintenance and filter change.....	1-8
1.6	Information for the operator	1-8
1.6.1	Training by manufacturer prior to commissioning.....	1-8
1.6.2	User requirements.....	1-8
1.6.3	Conformity	1-8
1.6.4	Manufacturer's warranty.....	1-9
1.6.5	Technical changes.....	1-9
1.7	Disposal.....	1-9
2	Product description	2-3
2.1	Components	2-4
2.1.1	Extracorporeal system	2-4
2.1.2	Dialyzer	2-4
2.1.3	User interface.....	2-4
2.1.4	Control system.....	2-5
2.1.5	Balance chamber and UF-control.....	2-5
2.1.6	Water preparation	2-5
2.1.7	Concentrate preparation.....	2-5
2.2	Basic models.....	2-6
2.2.1	Dialog+ single-pump machine	2-9
2.3	Symbols on the dialysis machine	2-10
2.4	Control elements and information on the monitor	2-11
2.5	Overview of all icons.....	2-13
2.6	Entering numerical values.....	2-20
2.7	Using the timer/stop watch.....	2-23
3	Installation and commissioning.....	3-3

3.1	Scope of supply	3-3
3.2	Storage	3-3
3.2.1	Storage in originally packed condition	3-3
3.2.2	Interim storage of devices ready for operation	3-3
3.2.3	Decommissioning	3-3
3.3	Transportation	3-4
3.3.1	Rolling	3-4
3.3.2	Carrying	3-5
3.4	Installation site	3-6
3.4.1	Electrical connection	3-6
3.4.2	Protection against water damage	3-6
3.4.3	Potentially explosive areas	3-6
3.5	Water supply	3-7
3.5.1	Quality of water and dialysate	3-7
3.5.2	Disposal of used fluids	3-7
3.6	Initial commissioning	3-8
3.7	Setting date and time	3-8
3.8	Switching on and off	3-9
4	Therapy types	4-3
4.1	Hemodialysis (HD)	4-3
4.2	Phases of pure ultrafiltration	4-3
4.3	Methods of treatment	4-4
4.3.1	Double-needle procedure	4-4
4.3.2	Single-needle procedure	4-4
4.4	Effectiveness of dialysis (Kt/V)	4-5
5	Preparing for hemodialysis	5-3
5.1	Initiating hemodialysis	5-4
5.2	Automatic test	5-4
5.2.1	Operation during automatic test	5-5
5.2.2	Terminating the automatic test sequence	5-6
5.2.3	Completion of automatic test sequence	5-6
5.3	Reducing the warning sounds during preparation	5-6
5.4	Connecting the concentrate	5-8
5.5	Setting the rinsing parameters	5-9
5.6	Inserting, rinsing and testing the tubing system	5-11
5.6.1	Inserting standard A/V tubing	5-12
5.6.2	Rinsing and testing standard A/V tubing	5-14
5.6.3	Level regulation during Preparation (if present)	5-14
5.6.4	Inserting Streamline® bloodline	5-16
5.6.5	Rinsing and testing the tubing system	5-17
5.7	Preparing the heparin pump	5-18
5.7.1	Inserting the heparin syringe	5-18
5.7.2	Venting the heparin line	5-19

5.8	Setting the treatment parameters	5-20
5.8.1	Setting the dialysate parameters	5-21
5.8.2	Monitoring the dialysate	5-24
5.8.3	Sampling of dialysate for microbiology analysis	5-25
5.8.4	Setting the ultrafiltration parameters	5-27
5.8.5	Setting the pressure limits	5-29
5.8.6	Setting the heparin parameters	5-31
5.9	Rinsing the dialyzer	5-33
5.9.1	Rinsing the dialyzer using standard A/V tubing	5-33
5.9.2	Rinsing the dialyzer using Streamline® bloodline	5-34
5.10	Stand-by mode	5-35
5.10.1	Activating the stand-by mode	5-35
5.10.2	Switching off the stand-by mode	5-35
5.11	Power failure in preparation	5-36
5.12	Changing the bicarbonate cartridge during preparation	5-36
6	Initiating hemodialysis	6-3
6.1	Checking the patient data	6-3
6.2	Connecting the patient and starting hemodialysis	6-4
6.2.1	Level regulation in therapy (if present)	6-5
6.3	During hemodialysis	6-7
6.3.1	Monitoring the blood-side pressure limits	6-7
6.3.2	Treatment at minimum UF rate	6-9
6.3.3	Heparin bolus	6-10
6.3.4	Arterial bolus (saline)	6-10
6.3.5	Graphic representation of treatment parameters (trend)	6-12
6.3.6	Interrupting hemodialysis (bypass)	6-15
6.3.7	Completion of treatment	6-15
6.3.8	Terminating treatment	6-15
6.3.9	Continuing treatment	6-15
7	Ending hemodialysis therapy	7-3
7.1	Reinfusion	7-3
7.2	Emptying the cartridge after dialyzer drain	7-5
7.3	Emptying the dialyzer	7-5
7.3.1	Removing dialyzer and blood tubing system	7-5
7.4	Overview of the therapy carried out Touch icon	7-6
8	Disinfection	8-3
8.1	Procedure and disinfectants	8-3
8.2	Preparing for disinfection	8-5
8.2.1	Positioning the disinfectant container	8-5
8.2.2	Selecting the disinfection program	8-5
8.3	Automatic switch-off and restarting	8-7
8.3.1	Automatic switch-off after disinfection	8-7
8.3.2	Automatic switch-off and restarting	8-7

8.4	Chemical disinfection	8-8
8.5	Short chemical disinfection	8-9
8.6	Thermal disinfection	8-10
8.7	Disinfection of incoming water from water supply.....	8-11
8.7.1	Chemical disinfection with disinfecting solution from central water supply	8-12
8.7.2	Automatic chemical disinfection with disinfectant from central water supply	8-13
8.7.3	Thermal disinfection with hot permeate from central water supply	8-15
8.7.4	Rinsing the permeate inlet.....	8-16
8.8	Checking for disinfectant residues.....	8-17
8.9	Decalcification.....	8-18
8.9.1	Automatic descaling	8-18
8.10	Terminating disinfection	8-20
9	Single-needle procedure	9-3
9.1	Single-needle valve (SN-valve)	9-3
9.1.1	Preparing the therapy.....	9-3
9.1.2	Level regulation in SN-valve mode (if present).....	9-5
9.1.3	Running the therapy.....	9-7
9.1.4	Ending the therapy.....	9-8
10	Use of accessories and options.....	10-3
10.1	ABPM blood pressure monitoring.....	10-3
10.1.1	Cuff	10-3
10.1.2	Settings.....	10-5
10.1.3	Starting/stopping measurement.....	10-8
10.1.4	Showing and graphically displaying measured values.....	10-9
10.2	Bicarbonate cartridge holder	10-10
10.2.1	Inserting the cartridge.....	10-10
10.2.2	Changing the cartridge during dialysis.....	10-11
10.2.3	Emptying the cartridge after treatment.....	10-14
10.3	Central concentrate supply	10-15
10.4	Adimea™ Option UV – Kt/V.....	10-16
10.4.1	Setting the parameters.....	10-17
10.4.2	Graphic representation during therapy	10-18
10.4.3	Target warning.....	10-20
10.4.4	Extended functionality when using the patient therapy card.....	10-21
10.4.5	Kt/V table	10-23
10.5	Dialysis fluid filter.....	10-24
10.5.1	Use and mode of operation.....	10-24
10.5.2	Changing dialysis fluid filter.....	10-25
10.5.3	Resetting the data	10-28
10.5.4	Disinfection.....	10-29
10.6	Emergency power supply/battery	10-30
10.6.1	Charging indicator	10-31

10.6.2 Automatic battery test	10-31
10.6.3 Ending battery operation	10-32
10.7 Communication interfaces	10-32
10.7.1 Dialog+ computer interface (DCI)	10-32
10.8 Rinse bucket	10-32
10.8.1 Care of the rinse bucket	10-32
11 Configuration	11-3
11.1 Automatic switch-off	11-3
11.2 Weekly disinfection program	11-5
11.3 Configuring the weekly disinfection program	11-6
11.4 Configuring profiles	11-9
11.4.1 Basic principles	11-9
11.4.2 Setting profile parameters	11-9
11.5 UF profiles	11-11
11.5.1 Selecting UF profiles	11-11
11.5.2 UF profile table	11-13
11.6 Patient therapy chip card	11-18
11.6.1 Erasing data from patient therapy card	11-18
11.6.2 Entering the patient name	11-19
11.6.3 Reading patient data	11-20
11.6.4 Storing patient data (parameter settings)	11-20
11.7 Theoretical Kt/V calculation	11-21
11.8 Adjusting monitor brightness	11-26
11.9 Selecting language of screen text	11-27
11.10 Editing trend group parameters	11-28
12 Maintenance and cleaning	12-3
12.1 External cleaning	12-3
12.2 Preventive maintenance and technical safety inspection	12-4
12.2.1 Regular preventive maintenance	12-4
12.2.2 Technical safety inspection	12-5
12.2.3 Accessories, disposable items and expendable parts	12-5
12.3 Technical service and warranty	12-5
12.3.1 Warranty	12-5
12.4 Disposal of old dialysis machines	12-5
13 Alarms and remedial action	13-3
13.1 Displaying and resetting alarms	13-3
13.2 Alarms and consequences	13-5
13.3 Remedying SAD alarms when using standard A/V tubing systems	13-39
13.4 Manual blood return	13-41

13.5	Muting acoustic signals.....	13-43
13.5.1	Muting acoustic signals for alarms	13-43
13.5.2	Muting acoustic signals for messages.....	13-43
14	Accessories and options.....	14-3
14.1	Accessories and options.....	14-3
14.2	Additional accessories.....	14-4
14.3	Configurations	14-4
15	Technical data	15-3
15.1	General technical data	15-3
15.2	Ambient conditions.....	15-4
15.3	Recommended safe distances	15-5
15.4	Dialysate system	15-6
15.5	Extracorporeal circulation.....	15-9
15.6	Materials coming into contact with water, dialysate, dialysis concentrates and/or disinfectants	15-11
15.7	ABPM blood pressure monitoring.....	15-12
15.8	Technical data of Crit-Line® interface.....	15-13
16	Appendix	16-3
16.1	Dialysate flow chart	16-3
16.1.1	Key to dialysis flow chart	16-3
16.1.2	Flow chart Dialog ⁺	16-5
16.2	Service protocols	16-6

Table of contents

1	Safe handling	1-3
1.1	Intended use and indications	1-3
1.2	Contraindications	1-3
1.3	Side effects	1-3
1.4	About these Instructions for Use.....	1-4
1.4.1	Applicability.....	1-4
1.4.2	Target group	1-4
1.4.3	Warnings, notices and symbols in these Instructions for Use	1-4
1.4.4	Abbreviations	1-6
1.5	Special hazards and precautions.....	1-6
1.5.1	Special patient conditions.....	1-6
1.5.2	Electrical hazards.....	1-7
1.5.3	Electromagnetic interaction	1-7
1.5.4	Maintenance and filter change.....	1-8
1.6	Information for the operator	1-8
1.6.1	Training by manufacturer prior to commissioning.....	1-8
1.6.2	User requirements.....	1-8
1.6.3	Conformity	1-8
1.6.4	Manufacturer's warranty.....	1-9
1.6.5	Technical changes.....	1-9
1.7	Disposal.....	1-9

1 Safe handling

1.1 Intended use and indications

This dialysis machine can be used for implementing and monitoring hemodialysis treatments for patients with acute or chronic kidney failure. The system can be used in hospital, health center and outpatient dialysis center settings when prescribed by a physician.

The following types of renal replacement therapy can be carried out with the system:

- Hemodialysis (HD) with or without phases of pure ultrafiltration
 - high flux hemodialysis
 - low flux hemodialysis

1.2 Contraindications

There are no known contraindications for chronic hemodialysis.

The doctor in charge of the treatment is responsible for choosing the suitable therapy, based on medical and analytical findings and the general health and condition of the patient.

1.3 Side effects

Hypotension, nausea, vomiting and cramps are possible side effects.

Hypersensitivity reactions caused by using the necessary tubing and filter materials have been observed in only a few cases. For more information on this matter, please refer to the product information provided with the disposables.

1.4 About these Instructions for Use

These Instructions for Use form an integral part of the dialysis machine. They describe the appropriate and safe use of the dialysis machine at all stages of operation.



The dialysis machine must always be used in accordance with the Instructions for Use.

Always keep the Instructions for Use at the dialysis machine for later use.

Pass on Instructions for Use to any future user of the dialysis machine.

1.4.1 Applicability

Art. no.

These Instructions for Use apply to Dialog⁺ dialysis machines with the following article numbers (art. no.):

- 710200K
- 710200L (with bicarbonate cartridge holder)
- 710220U (with Adimea, DF filter, WAN-BSL)
- 710200S (with bicarbonate cartridge holder, Adimea, DF filter, WAN-BSL)

Software version

These Instructions for Use apply to software version 9.1x (x = any)

1.4.2 Target group

The target group for these Instructions for Use is the dialysis medical staff.

The dialysis machine may only be used by persons instructed in its appropriate operation. Furthermore, all clinical parameters have to be ordered and controlled by a physician.

1.4.3 Warnings, notices and symbols in these Instructions for Use

Warnings in these Instructions for Use point out particular hazards for users, patients, third parties and the dialysis machine. They also suggest measures that can be taken to avoid the respective hazard.

There are three levels of warning notices:

Warning term	Meaning
DANGER	Imminent danger that can lead to death or serious injury if not avoided
WARNING	Potentially imminent danger that can lead to death or serious injury if not avoided
CAUTION	Potentially imminent danger that can lead to minor injuries or damage to equipment if not avoided

The warning notices are highlighted in the following manner (see below example for a CAUTION warning):

 CAUTION	<p>Here the type and source of the danger are listed, and possible consequences if the preventive measures are not followed!</p> <p>➤ This is the list of measures to prevent the hazard.</p>
--	---

	<p>This is the list of important information, directly or indirectly relating to safety and the prevention of damage.</p>
---	---



This is additional useful information concerning safe procedures, background information and recommendations.

➤ This symbol marks the instructions for action.

1.4.4 Abbreviations

ABPM	Automatic blood pressure monitoring
BPA	Arterial blood pump
BPV	Venous blood pump
HD	Hemodialysis
HP	Heparin pump
PA	Arterial pressure
PBE	Blood-side entry pressure at dialysis machine
PBS	Blood pump control pressure for single-needle procedure
PV	Venous pressure
RDV	Venous red detector
SAD	Safety air detector
SAKA	Arterial tube clamp
SAKV	Venous tube clamp
SN	Single-needle
TMP	Trans membrane pressure
TSM	Technical support and maintenance mode
UF	Ultrafiltration
ZKV	Central concentrate supply

1.5 Special hazards and precautions

1.5.1 Special patient conditions

The patient's physician must be notified of any special patient conditions, such as unstable circulation or hypokalemia, prior to therapy.



Fluid Balance deviations can exceed a level that can be tolerated by low weight patients, even if deviations are within the specified Dialog⁺ accuracy value, and in particular if the weight of the patients is equal or lower than 30 kg.

- **The treatment of these patients shall be performed under the full supervision of the physician.**
- **In these cases, the use of an additional device to measure the weight loss is recommended.**
- **The appropriate dialyzer and blood line must be selected according to the patient's size, weight and treatment type.**

1.5.2 Electrical hazards

The dialysis machine contains life-threatening electrical voltages.



Risk of electric shock and fire.

- **Always insert mains plug completely into the mains socket.**
- **Always pull/push on the plug and not on the mains cord to connect or disconnect the mains plug.**
- **Avoid damage of the mains cord. (For example by running over it with the machine.)**

It must not be used or connected to mains voltage if the housing or the power cord is damaged in any way. A damaged dialysis machine must be submitted for repairs or disposal.

Interaction with other devices

When using the dialysis machine in combination with other therapeutic devices, a potential equalization device must be connected, since the leakage currents from all connected devices are summarized and the electrostatic discharge from the environment to Dialog⁺ may occur.

Do not connect customary consumer devices to the same power socket as the dialysis machine or connect them in parallel.

Use with central-venous catheter

For patients with a central venous catheter, a higher degree of protection against electric shock is required. As electric currents can run through supply lines, via the dialyzer, the catheter, the patient and every conducting object in the vicinity of the patient, electrical potential equalization must be provided. As soon as earth potential equalization is connected to the machine the patient leakage current has to be below 10 µA, which complies with the limit value for patient leakage current of type CF. A potential equalization cable is available, which can be connected to the bolt at the rear side of the machine. The ambient conditions of the premises must be in accordance to the local requirements (see also chapter 1.6.4).

1.5.3 Electromagnetic interaction

The dialysis machine has been developed and tested in accordance with the valid standards for interference suppression and EMC. It cannot, however, be guaranteed that no electromagnetic interaction with other devices will occur (examples: mobile phones, computer tomograph [CT]).



Risk of electrostatic discharge from other devices.

- **It is recommended that mobile phones and other devices emitting strong electromagnetic radiation only be used at a minimum distance, according to IEC 60601-1-2 (see also chapter 15.3).**



If other therapeutic or diagnostic medical devices are placed on, near by, or nonmedical devices are used near Dialog⁺, they may have an influence on electromagnetic interactions. The user must observe the proper operation of Dialog⁺ and all other machines when these combinations exist.

1.5.4 Maintenance and filter change

In order to protect patients against cross-contamination, the transducer protectors of standard tubing systems are equipped with hydrophobic 0.2 µm filters.



Risk to patient due to infection as a result of contamination of the transducer protector on the tubing system!

- Replace the machine-side transducer protector if it has been contaminated with blood.
- Instruct technical service to replace transducer protector, tubing and pressure port.
- Execute disinfection after replacement.
- Only use the machine again when the filter has been changed.

1.6 Information for the operator



CAUTION
Rx only!

1.6.1 Training by manufacturer prior to commissioning

The operator may use this device only after the manufacturer has trained the responsible staff based on these Instructions for Use.

1.6.2 User requirements

The dialysis machine may be used only by persons instructed in its appropriate operation.

The operator must ensure that the Instructions for Use are read and understood by all operators of the dialysis machine.

Prior to using the dialysis machine, check for safe functioning and correct conditioning of the dialysis machine.

1.6.3 Conformity

This dialysis machine complies with the requirements of the generally applicable standards in their respective valid version:

- ANSI/AAMI/IEC 60601-1
- IEC 60601-2-16

Additional equipment connected to the analog or digital interfaces of the dialysis machine must demonstrably meet the relevant IEC specifications (e.g. IEC 60950 for data processing devices and IEC 60601-1 for electromedical devices). Also, all

configurations must conform with the valid version of the System Standard IEC 60601-1-1.

Persons connecting additional devices to signal input or output components are performing a system configuration and are thus responsible for ensuring that the system is compliant with a valid version of the System Standard IEC 60601-1-1. In case of questions, please contact your local specialist dealer or technical service.

In each country the distribution of the machine is carried out provided that the device is registered and classified according to the local regulations.

USA

In the USA, the dialysis machine is a class II device complying with the fundamental requirements of 21 CFR (Code of Federal Regulations) §876.5860.

1.6.4 Manufacturer's warranty

The manufacturer, assembler, installer or implementer may only be responsible for the effects on the safety, reliability and performance of the device, if:

- the assembly, expansion, readjustments, changes or repairs were carried out by a person authorized by the manufacturer.
- the electrical installation of the affected room complies with the valid national requirements on the equipment of medical treatment rooms (i. e. IEC stipulations).

The device may be operated only if the manufacturer or an authorized person, acting on behalf of the manufacturer:

- has carried out a functional check on site (initial commissioning),
- if the persons appointed by the operator to use the device have been trained in the correct handling, use and operation of the medical product with the aid of the Instructions for Use, enclosed information and maintenance information and
- if the quality of the water used with the device corresponds to the relevant standards.

1.6.5 Technical changes

We reserve the right to change our products in line with further technical developments.

1.7 Disposal

Dialysis machines may be returned to the manufacturer for disposal in accordance with the applicable disposal guidelines.



The Dialysis machine has to be disinfected according to regulations before disposal.

Table of contents

2	Product description	2-3
2.1	Components	2-4
2.1.1	Extracorporeal system	2-4
2.1.2	Dialyzer	2-4
2.1.3	User interface.....	2-4
2.1.4	Control system.....	2-5
2.1.5	Balance chamber and UF-control.....	2-5
2.1.6	Water preparation	2-5
2.1.7	Concentrate preparation.....	2-5
2.2	Basic models.....	2-6
2.2.1	Dialog ⁺ single-pump machine	2-9
2.3	Symbols on the dialysis machine	2-10
2.4	Control elements and information on the monitor	2-11
2.5	Overview of all icons.....	2-13
2.6	Entering numerical values.....	2-20
2.7	Using the timer/stop watch.....	2-23

2 Product description

The Dialog⁺ is a Hemodialysis Delivery System Machine available in four models

- Model # 710200K: Dialog⁺ single-pump
- Model # 710200L: Dialog⁺ single-pump, with bicarbonate cartridge holder
- Model # 710200U: Dialog⁺ single-pump, with Adimea, DF filter, WAN-BSL
- Model # 710200S: Dialog⁺ single-pump, with bicarbonate cartridge holder, Adimea, DF filter, WAN-BSL

The Dialog⁺ machine is suitable for hospital hemodialysis and also for dialysis centers. It can use and store different profiles for many parameters such as: UF, sodium, bicarbonate, heparin, dialysate flow, and temperature.

Treatment can be performed with bicarbonate or acetate concentrate supplied from a canister or from central supply. A bicarbonate cartridge can be used as well.

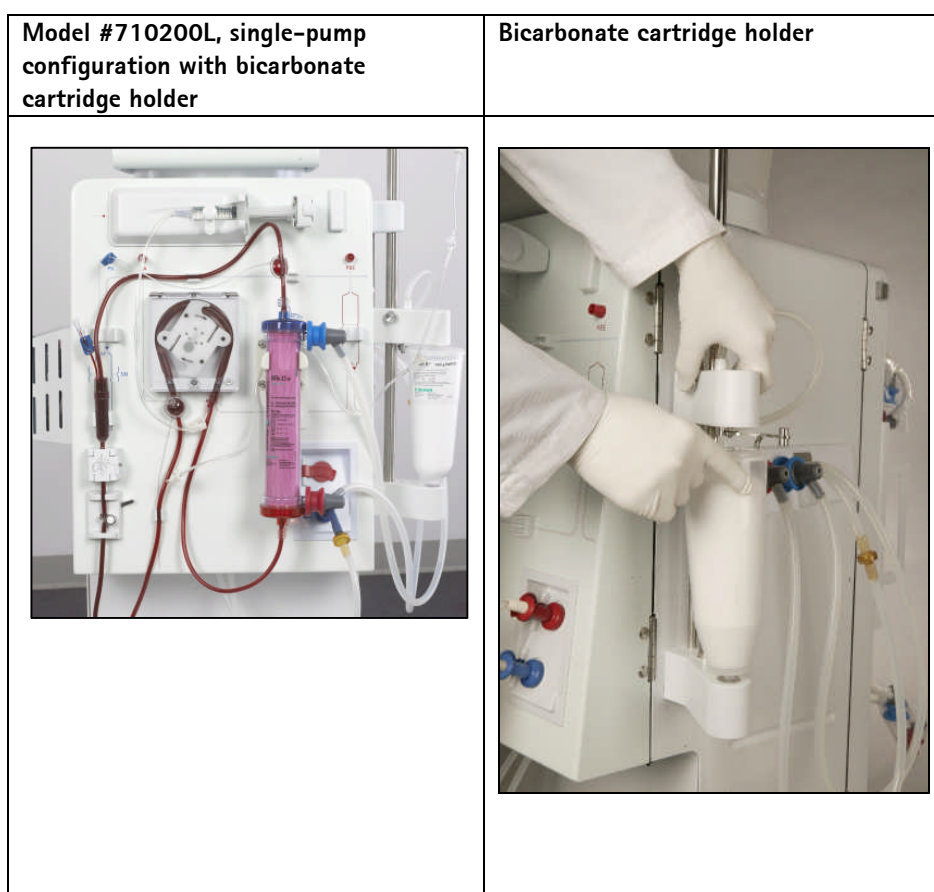

Fig. 2-1 Dialog⁺ system models

2.1 Components

		The Dialog+ system consists of the following components:
"Disposables"	}	– Extracorporeal circulation system
		– Dialyzer
"Dialog+ machine"	}	– User interface
		– Control and safety monitoring systems, e.g. auto clamps, alarms, etc.
		– Balance chamber and UF control
		– Water preparation
		– Concentrate preparation

2.1.1 Extracorporeal system

The extracorporeal system consists of the machine's peristaltic pumps, which are used to transport the blood to the dialyzer and from the dialyzer back to the patient.

Blood is pumped through a disposable extracorporeal system mainly composed of tubing, connectors, drip chambers and the dialyzer.

Peristaltic pumps withdraw blood from the patient's vascular access into the dialyzer.

A syringe pump pumps heparin into the bloodlines in a quantity and time set by the user to avoid the coagulation of the blood in the disposable circuit and the dialyzer filter.

2.1.2 Dialyzer

The capillary dialyzer houses semipermeable hollow fibers encased in a plastic canister. The dialyzer is used to correct the concentration of water-soluble substances in the patient's blood before delivering it back to the patient. The blood is separated from the dialyzing fluid by a semi-permeable membrane that permits bidirectional diffusive transport and ultrafiltration. The process also allows diffusion of substances from the dialyzing fluid into the blood.

2.1.3 User interface

The user interface is a display panel that provides communication between the machine and the user. On the display it is possible to visualize all the dialysis parameters and relevant information about the procedure and alarm conditions.

By touching the icons on the screen, the user can input all the parameters for the treatment such as: dialysis time, UF volume and heparin pump flow. Several profiles for the procedure can be selected and set via the interface.

The five buttons at the bottom of the screen (see Fig. 2-6) have fixed functions i.e., control the arterial pump, to enter and confirm the entry input and to reset the alarms.

2.1.4 Control system

The control system is divided into two parts:

The top level control system connects the interface with the user and transmits data to and from other modules. The low level control system controls and monitors the machine and its functions and also communicates with the top level control system. Both systems operate independently of each other.

2.1.5 Balance chamber and UF-control

The balance chamber system is a closed system and consists of two chambers, each with a flexible membrane, allowing it to fill the chambers from one side while an identical volume is emptied to the other side. Therefore the outlet fluid volume is equal to the input fluid volume.

Each membrane has a magnetic sensor which reads the membrane position and controls the opening and the closing of each sub compartment.

The control of the dialysate volume is also carried out by the balance chamber. The difference between used dialysate and fresh dialysate is the ultrafiltration volume, which is removed from the blood side of the dialyzer. Ultrafiltrate removal is carried out by the UF pump.

2.1.6 Water preparation

Purified water coming from the reverse osmosis system has to be degassed and tempered to a predetermined temperature, which is set by the user (usually 37°C/99 °F), before the concentrate is prepared. A degassing chamber and a heater are integral to the system.

2.1.7 Concentrate preparation

In bicarbonate dialysis, which is the most common procedure, concentrate preparation consists of mixing the heated and degassed water with bicarbonate concentrate and acid concentrate. The accuracy of dialysate concentration is controlled by conductivity sensors. If the concentration is incorrect, the dialyzer will be bypassed.

2.2 Basic models



The basic model Dialog+ single-pump machine is shown in the figure below. The legend highlights the components installed in all basic models.

Front view

Legend

- 1 Venous pressure sensor connection (blue)
- 2 Arterial pressure sensor connection (red)
- 3 Heparin pump
- 4 Syringe stop
- 5 Blood pump (one or two blood pumps depending on basic model)
- 6 Rinsing chambers for concentrate rods
- 7 Venous tube clamp
- 8 Safety air detector (SAD) and red sensor
- 9 Fixture for the chamber of the blood tubing system
- 10 Fixture for blood tubing system

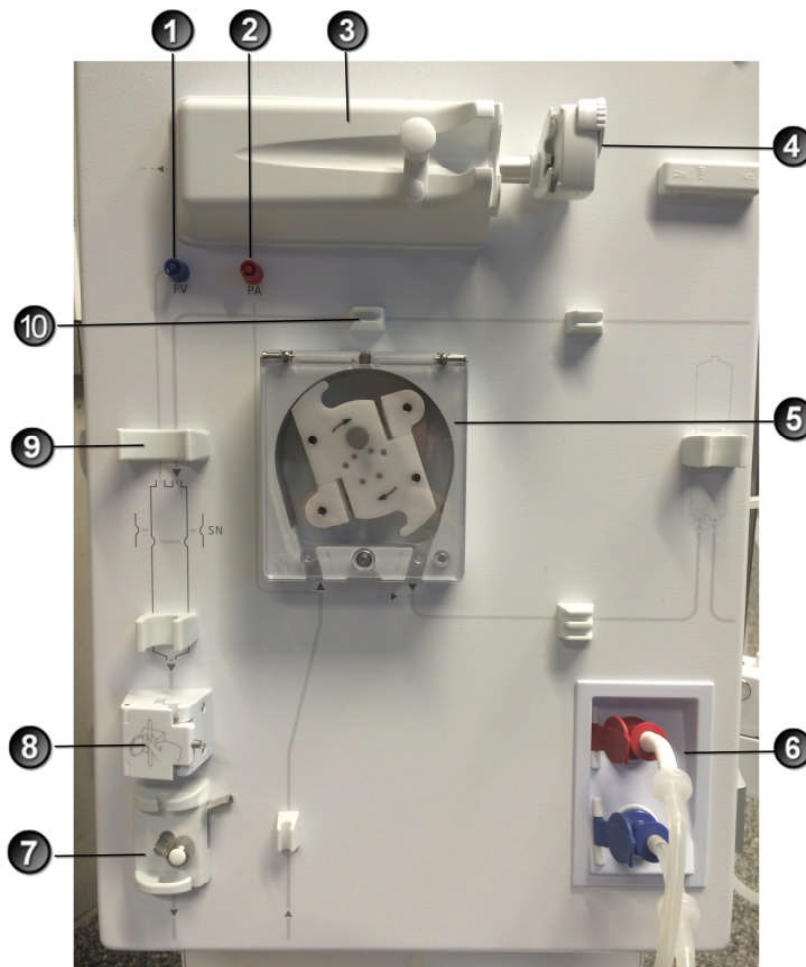

Fig. 2-2 Basic model single-pump, front view

Legend

- 1 Infusion pole (in some models, pole may not be adjustable)
- 2 Multi Functional Tray
- 3 Bicarbonate cartridge holder (optional)
- 4 Connection for central concentrate supply (optional)
- 5 Connection for disinfectant
- 6 Connections for dialyzer tubing and rinsing bridge
- 7 Card reader
- 8 Wheel lock

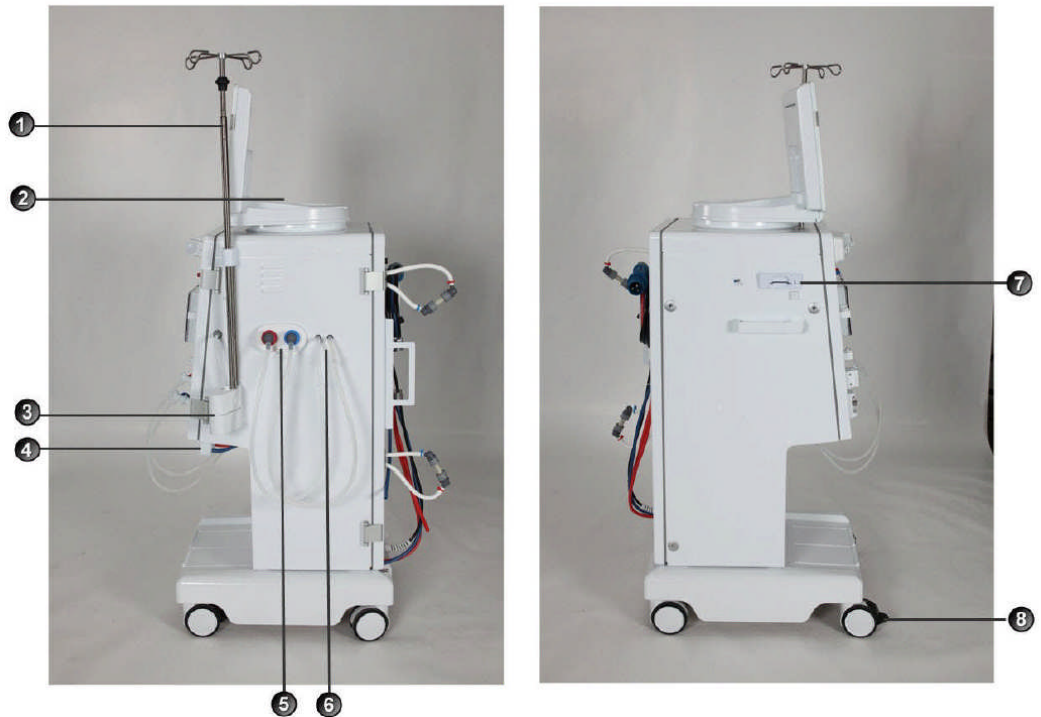
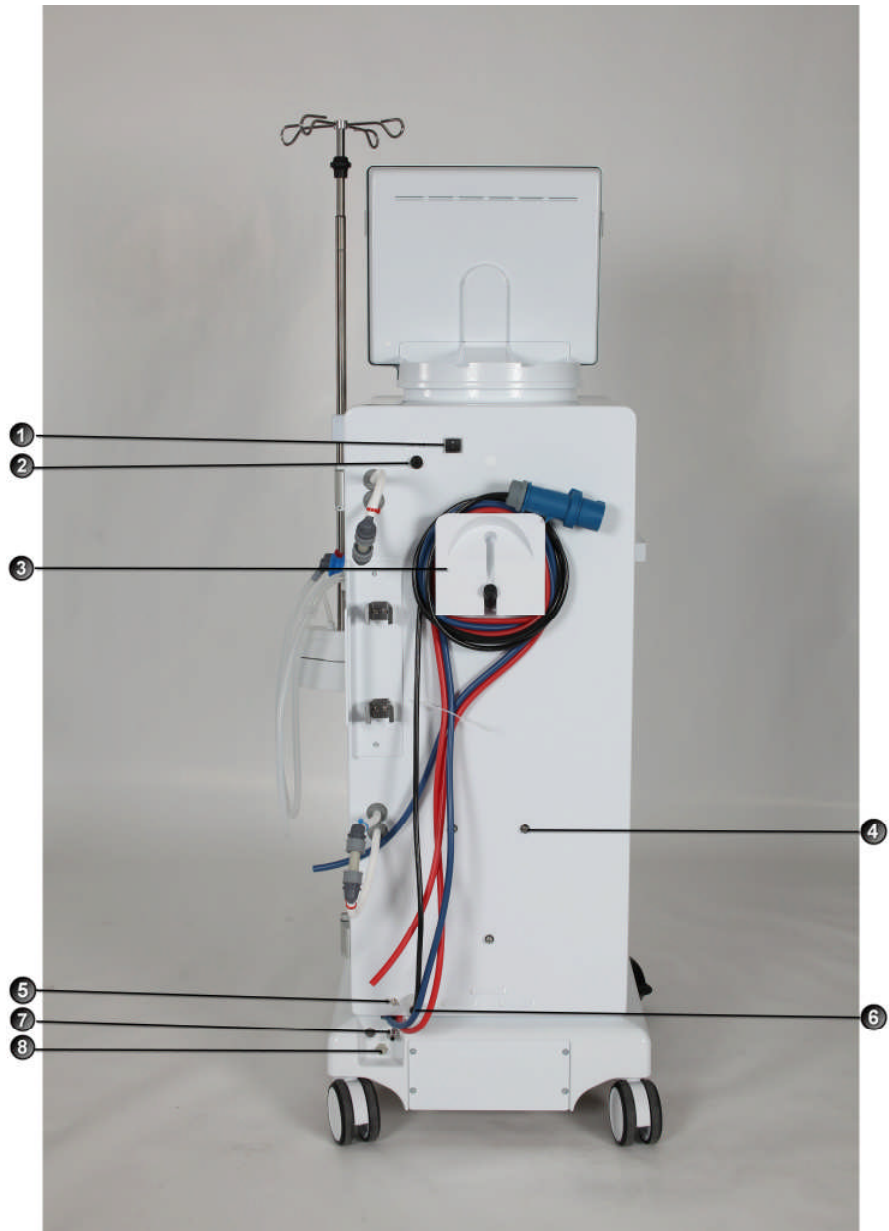

Fig. 2-3 Basic model, side views

Legend

- 1 Mains switch
- 2 WAN-BSL
- 3 Crank for manual blood return
- 4 Fixture for disinfectant container
- 5 Ground connection
- 6 Power cord
- 7 Water inlet
- 8 Dialysate outlet



- 7 Water inlet
- 8 Dialysate outlet

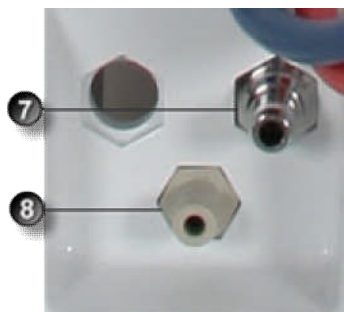

Fig. 2-4 Basic model, rear view

2.2.1 Dialog⁺ single-pump machine

The Dialog⁺ single-pump dialysis machine is suitable for hospitals, health centers and outpatient dialysis centers. It offers the following features as standard:

- Color screen and on-screen operation (color touch screen)
- Acetate/bicarbonate operation
- Volumetric ultrafiltration
- Heparin syringe pump
- Heat exchanger
- Fixed or freely selectable profile controls for dialysate composition, temperature and flow rate, for heparin supply and for ultrafiltration

The following features are available as additional accessories/options:

- Automatic blood pressure monitoring (ABPM)
- Bicarbonate cartridge holder
- Level regulation
- Central concentrate supply (ZKV)
- Dialysis fluid filter
- Dialysis fluid filter holder
- Emergency power supply
- Data interface
 - Dialog⁺ computer interface (DCI)
 - WAN BSL (Bed Side Link): Card reader and interface to data management system
 - Card reader
- Adimea™ Option UV-Kt/V

Therapy types

The Dialog⁺ dialysis machine with a single blood pump can be used for the following therapy procedures:









- Hemodialysis (HD) with or without phases of pure ultrafiltration
- High-flux hemodialysis
- Low-flux hemodialysis

Methods of treatment

The Dialog⁺ dialysis machine with a single blood pump can be used for the following therapy methods:

- Double-needle procedure
- Single-needle procedure

2.3 Symbols on the dialysis machine

	Observe Instructions for Use Observe Safety information
	Type B applied part Classification acc. to IEC 60601-1
	Type BF applied part Classification acc. to IEC 60601-1
	Electrical ground
	Dialysis machine OFF
	Dialysis machine ON
	Alternating current
	Schematic illustration on safety air detector (SAD), showing the correct way of installing the tube
	Connection for optional automatic blood pressure monitoring (ABPM)

2.4 Control elements and information on the monitor

Signal lamps

Signal lamps on the left and right of the monitor light up in three different colors to indicate the conditions "Operation", "Warning" and "Alarm".

Legend

- 1 Signal lamps:
 Green = operation
 Yellow = warning/note
 Red = alarm
- 2 Buttons on the monitor

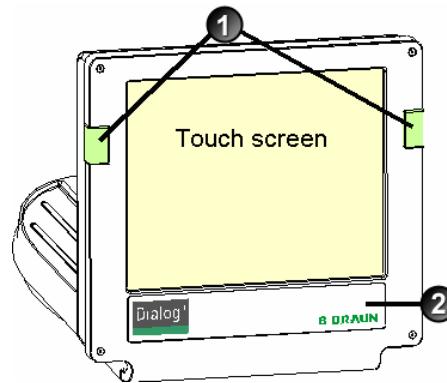

Fig. 2-5 Monitor

Buttons on the monitor

Even with the screen switched off (e.g. during cleaning), the basic functions of the dialysis machine can be controlled via the buttons on the monitor.

The "+" and "-" buttons (buttons 2 and 4) automatically count up or down by holding the button down.

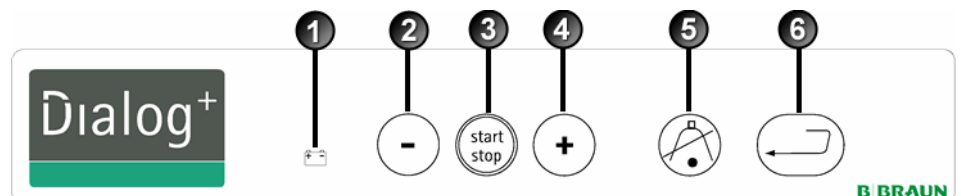

Fig. 2-6 Buttons on the monitor

Legend

- | | |
|---|---|
| 1 Battery symbol (display only): Battery charging | 4 Increase blood pump speed |
| 2 Reduce blood pump speed | 5 Confirm alarm (when button is illuminated); switches off the alarm buzzer |
| 3 Switch on/switch off blood pump | 6 Enter button: Confirm entered data and reset information (if button is illuminated) |

Touch Screen

Most functions of the dialysis machine are controlled via the touch screen. The screen displays different contents (windows) depending on the activated program section. Different parts (fields and icons) of the screen react to touch. By touching one of these areas, another window is called up or a stored action is triggered.

Some windows show a lateral scroll bar. They could be scrolled by moving a finger on the scroll bar.

Legend

- 1 Screen
- 2 Fields
- 3 Icons
- 4 Call up help function for explaining the icons

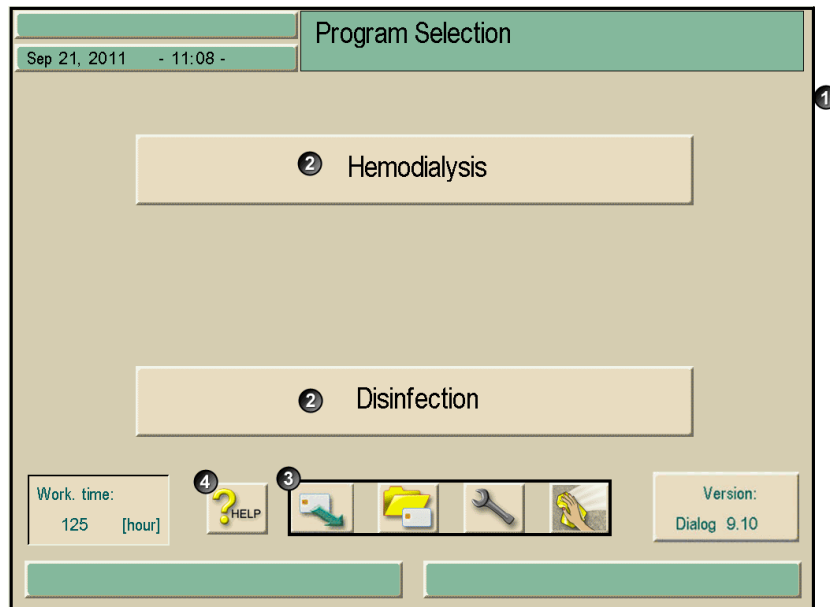





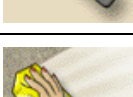
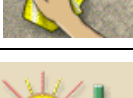



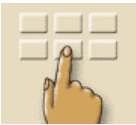
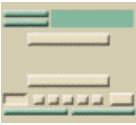



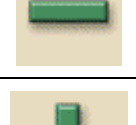
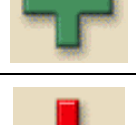



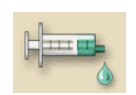



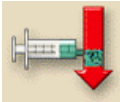

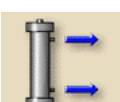
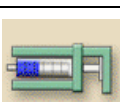
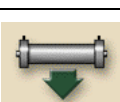

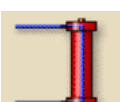
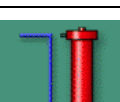

Fig. 2-7 Screen display

2.5 Overview of all icons











Icons are control buttons on the touch screen used for operating the dialysis machine. Depending on the displayed window, different icons are available, which all represent a specific action. By touching an icon, the respective action is carried out. A list of all icons is provided below.



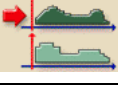



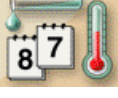



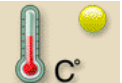

	Leave window and accept data
	Leave window without accepting data
	Help function for explaining the icons
	History of current disinfection
	Service screen
	Switch off all icon functions for 10 sec to allow cleaning of monitor
	Set brightness of monitor
	Leave current window
	Overview/ Table of contents
	Related parameter window





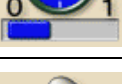

	Set treatment parameters
	Return to program selection
	Erase chip card
	Read patient data from chip card
	Save patient data to chip card
	Select further setting options
	Reduce value
	Increase value
	Red symbol: error symbol during reading of patient data from chip card to be consistent
	In profile window (except for UF profile): open numerical keypad for resetting the profile to a setting
	Key pad for entering numerical values
	Give heparin bolus
	Give arterial bolus (e.g. saline)

	Window for setting arterial bolus
	Dialyzer rinsing program with simultaneous ultrafiltration
	Empty dialyzer – dialysate is siphoned out of the dialyzer
	Set heparinization data
	Reset filter, empty (option DF filter)
	Filter data (only active if option DF filter has been installed) Save filter data to card reader
	Dialysis on main connection – dialysate flows through dialyzer
	Dialysis bypass – no dialysate in dialyzer
	Start reinfusion
	Change bicarbonate cartridge

	Change to therapy mode
	Change to "Therapy end" mode
	Disinfection from water supply – inlet
	Disinfection from water supply – discharge
	Set dialysate data
	Activate stand-by
	Set ultrafiltration data
	Minimum ultrafiltration
	Set pressure limits
	Single-needle selection and settings
	Ultrafiltration profiles
	Profile settings for the respective parameter

	Linear profile in case of specified start and end values
	Exponential profile in case of specified start and end values
	Non-invasive blood pressure monitoring (ABPM, option)
	Time setting (ABPM, option)
	Graphic representation of different parameters of therapy course
	Determine selection of graphically represented parameters
	Screen for entering laboratory values (urea) for Kt/V calculation
	UV-Kt/V measurement (option Adimea™)
	Save dialysis effectiveness and list of treatment values and Kt/V values
	Save disinfection data Weekly disinfection program
	Disinfection screen

	Start thermal disinfection
	Start central thermal disinfection
	Start chemical disinfection from water supply
	Start brief disinfection/cleaning
	Start disinfection program
	Start central rinsing
	Activate automatic switch-on of dialysis machine at the programmed time
	Activate automatic switch-off of dialysis machine after disinfection
	Disinfection history of last 150 disinfections
	Delete ABPM measured values list (option)
	Start ultrafiltration without dialysate (sequential therapy)
	Start ultrafiltration with dialysate
	Timer/stop watch

	Suppressed warning sounds during preparation
	Select language of screen text
	Level regulation: enter to level regulation function
	Level regulation: decreasing chamber level
	Level regulation: increasing chamber level
	List of stored Adimea™ curves

2.6 Entering numerical values

The changing of values is based on the same principle for all parameters. We are therefore providing an example. The example refers to the change of the parameter **UF quantity** on the ultrafiltration data window.

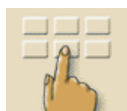

- Touch icon on window.

The selected icon lights up in green.

An icon appears for all parameter groups that can be changed.

If none of these icons is pressed within a preset time, the icons are switched off again. The preset time can be set by the service engineer in the service program.



- Touch desired icon (shown here: icon for calling up ultrafiltration data window, see Fig. 2-8).

The selected icon lights up in green.

The preset values for the parameter are displayed.

- Touch value to be changed on screen (shown here: value for UF quantity 2000 mL, see Fig. 2-8).

A field of icons for changing the value is displayed.

The desired value lights up in green.

Legend

- 1 Reduce value
- 2 Increase value
- 3 Call up keypad for entering values
- 4 Example: Calling up "Ultrafiltration data" screen

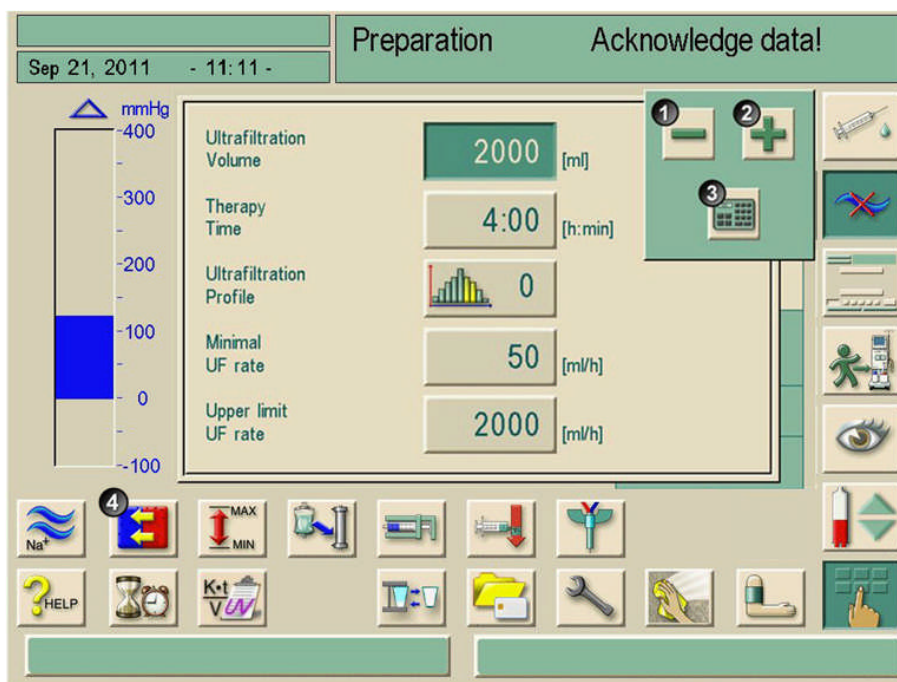
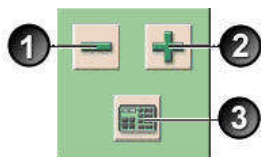

Fig. 2-8 Icons for changing the value

i

The dialysis machine can be set in the service program in such a way that a keypad appears immediately after the value to be changed has been touched. In this case, the keypad has no **O.K.** icon. To confirm entry, press **↵** on the monitor.



- Reduce value: Touch icon 1 until the desired value has been reached.
- Increase value: Touch icon 2 until the desired value has been reached.
- Enter different value: Touch icon 3.

A keypad is displayed. The permissible setting range is specified in square brackets below the numerical value (shown here: 100 ... 20000, see Fig. 2-9).

i

By pressing the icons 1 and 2, the setting could be adjusted up or down.

Legend

- 1 Numerical keys
- 2 Change sign of numerical value
- 3 Delete set numerical value
- 4 Leave window and accept data
- 5 Leave window without accepting data



Fig. 2-9 Numerical keypad

i

Delete the set numerical value: Touch key 3 on keypad.

Interrupt entry of numerical value and return to main window: Touch key 5.

If a value outside the permissible range is entered, the message **Limits exceeded** is displayed below the entered value.

- Enter value using keypad keys 1.
- If necessary, change sign via icon 2.
- Confirm entry with icon 4.

To access all of the groups of parameters, "shortcuts" can be used. Touch the parameter which should be changed or a concerning graphic indicator on the main screen. The corresponding window of the group of parameters will open as shown in Fig. 2-10.

The following screen shows the available shortcut squares in frames.

Legend

1 Help icon, active

□ Shortcuts

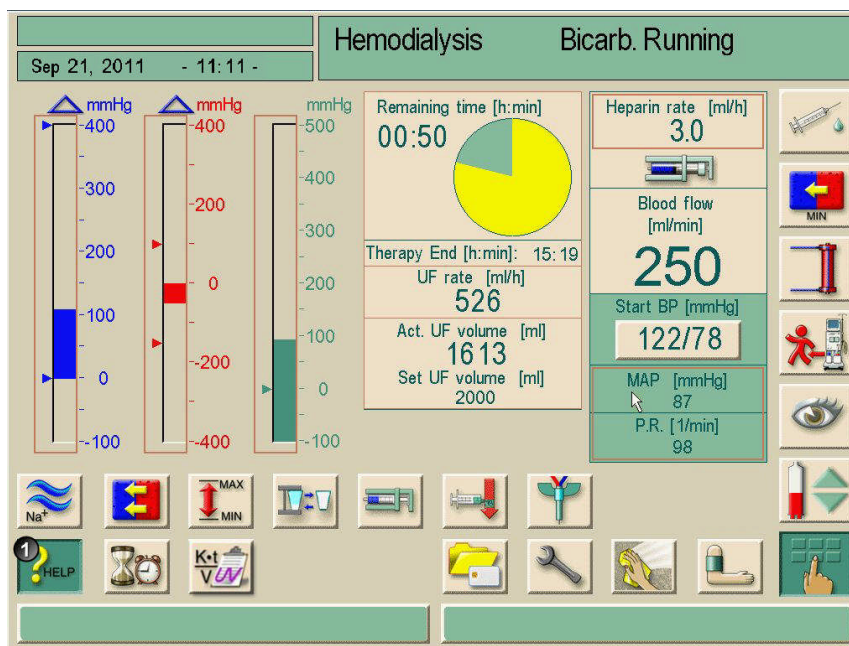

Fig. 2-10 Shortcut squares during activated help button

If a "shortcut" was touched inadvertently, or if no parameters are entered, the parameter window will close automatically after 10 seconds.

The frames marking the shortcuts will only appear if the help function is activated.

- Touch help button (1).
The "shortcuts" will be marked by brown frames.
- Touch help button again.
- The frames disappear.

i

Shortcuts are only active if the corresponding parameters are relevant for the actual therapy. For example: The setting of the venous limit can only be done by shortcut within Single-needle (SN) therapies.

Some shortcuts directly open the +/- window for changing the setting. For example: UF-quantity.

2.7 Using the timer/stop watch

The Dialog⁺ screen offers a timer or stop watch function for individual use. These functions are offered in the following phases:

- Preparation
- Therapy
- End of Therapy
- Selection of disinfection
- Disinfection

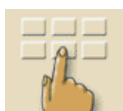

➤ Touch this icon.



➤ Touch this icon.
The following screen will appear.

Legend

- 1 Adjustment of an absolute time for a warning sound
- 2 Adjustment of an interval time for a warning sound
- 3 Displays rest or expired time
- 4 Starts/Stops/resets timer or stop watch
- 5 Starts/stops the timer for recurring warnings after input in 1 or 2
- 6 Switches off the warning sound after the chosen time interval
- 7 Opens an input window for reminder

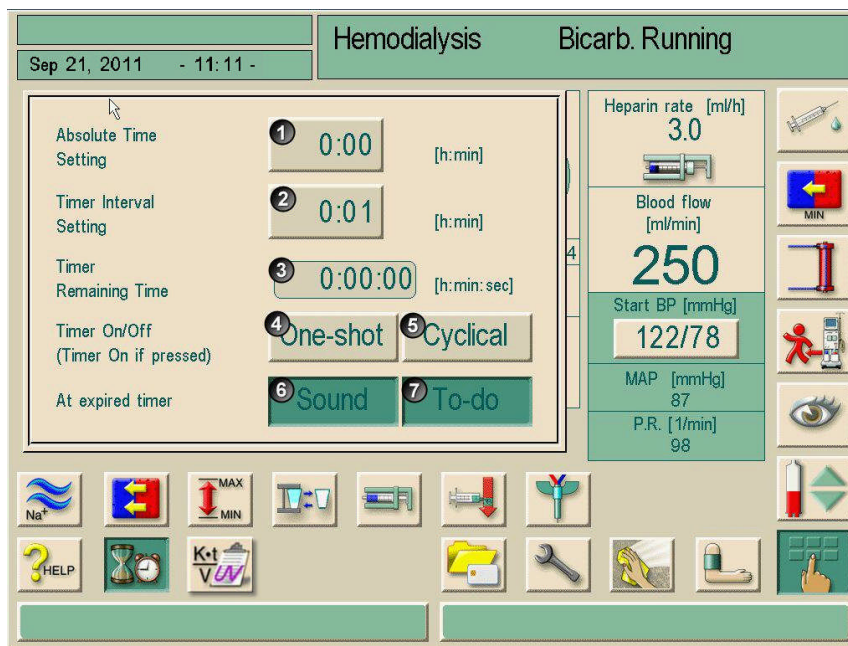

Fig. 2-11 Timer/stop watch function

If requested, button **6** activates or inactivates the warning sound.

The user could choose between a single warning or a cyclic warning with fixed intervals.

For a single warning

- Requested adjustment with button 1 or 2.
- Touch button 4 for single warning.

For cyclic warning:

- Requested adjustment with button 2 (button 5 automatically activated)
- Touch button 5
- The timer/stop watch function starts.
- To stop/reset touch respective button.

The timer function is counting the time shown in field 3 downwards, the stop watch is counting upward.

Touch button 7 for input of a reminder.

At expiry of an adjusted time a prompt appears in the message field "The set time interval expired" or an information window with written reminder appears. The signal lamps switch to yellow and an acoustic signal appears if it has been activated.

- Press the  button to acknowledge sound and message.



The timer/stop watch function is not interrupted by a possible power failure.

The running timer/stop watch function is shown with a symbol in the date line of the screen.

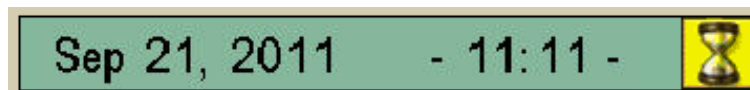

Fig. 2-12 Date line with timer symbol

Table of contents

3	Installation and commissioning.....	3-3
3.1	Scope of supply	3-3
3.2	Storage	3-3
3.2.1	Storage in originally packed condition	3-3
3.2.2	Interim storage of devices ready for operation	3-3
3.2.3	Decommissioning	3-3
3.3	Transportation	3-4
3.3.1	Rolling	3-4
3.3.2	Carrying.....	3-5
3.4	Installation site.....	3-6
3.4.1	Electrical connection	3-6
3.4.2	Protection against water damage	3-6
3.4.3	Potentially explosive areas.....	3-6
3.5	Water supply.....	3-7
3.5.1	Quality of water and dialysate.....	3-7
3.5.2	Disposal of used fluids.....	3-7
3.6	Initial commissioning	3-8
3.7	Setting date and time.....	3-8
3.8	Switching on and off	3-9

3 Installation and commissioning

3.1 Scope of supply

- Dialog⁺ dialysis machine
- Instructions for Use
- Suction tube with screw lid for disinfectant
- Tube clamps for tubes
- One container lid each with coupling for inserting suction rods (red and blue)
- Storage box
- In case of option Central Concentrate Supply: Supply from wall connection coupling to dialysis machine
- Special accessories

Check-in goods

- Unpack dialysis machine and check for completeness and damage.
- If there is damage, call technical service.

3.2 Storage

3.2.1 Storage in originally packed condition

- Store the dialysis machine in ambient conditions, as specified in section 15.2.

3.2.2 Interim storage of devices ready for operation

- Disinfect the dialysis machine.
- Store the dialysis machine in ambient conditions, as specified in section 15.2.

3.2.3 Decommissioning

- Disinfect the dialysis machine.
- Instruct technical service to empty the dialysis machine.
- Store the dialysis machine in ambient conditions, as specified in section 15.2.

3.3 Transportation

3.3.1 Rolling



Risk of damage if dialysis machine is tilted by more than 10°!

- Have 2 or more persons at hand for transporting the machine on stairs and inclined areas.
- Do not tilt the dialysis machine by more than 10°.

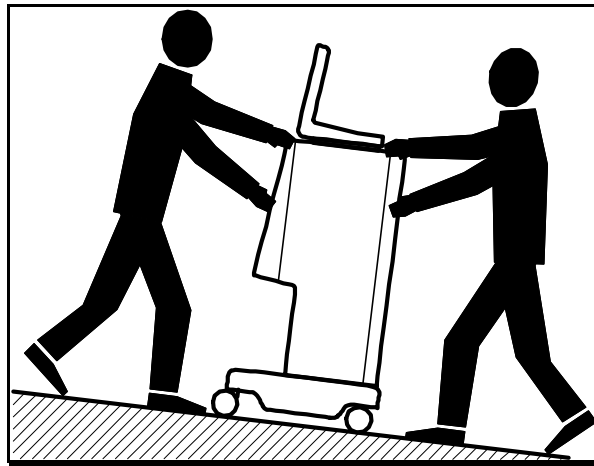

Fig. 3-1 Transport on stairs and slopes (2 persons)

- Release both brakes of front casters.
- Wheel the dialysis machine.
- Apply both brakes of front casters.

3.3.2 Carrying

For carrying, the dialysis machine can be held at the base, at the rear panel and/or the protrusion at the front of the machine, as shown in the following illustration.



Fig. 3-2 Holding points for carrying the dialysis machine



Danger of damage due to incorrect transportation (wrong holding points)!

➤ **Do not hold machine on monitor, on bicarbonate cartridge holder or on infusion pole when transporting.**

- Use a belt to secure monitor to infusion pole.
- Release caster brakes.
- Tilt the dialysis machine.
- Put down the dialysis machine.
- Apply caster brakes.

3.4 Installation site



Ambient conditions

Observe information about ambient conditions, see section 15.2.

3.4.1 Electrical connection

The existing mains voltage must correspond with the voltage specified on the rating plate.

The use of extension cables or adapters with the power cable or the mains socket is NOT permitted. Modifications of the power cable are forbidden! If the power cable has to be changed, only the original power cable listed in the spare parts list must be used.

Electrical installations in the room where the dialysis machine will be operated must conform with relevant regulations, e.g. IEC-stipulations. Regulations and deviations specific to the individual country must also be observed. For further information, ask technical service.

Using devices of protection class I the quality of the protective conductor is important. Regulations and deviations specific to the individual country must also be observed. For further information, ask technical service.

Each Dialog⁺ machine requires a dedicated 20 amp electrical service, with an isolated ground.

Grounding reliability can only be achieved when equipment is connected to an equivalent receptacle marked "hospital only" or "hospital-grade". North American medical equipment cords and plugs have to be "hospital-grade" or "hospital only", meaning they are subject to special requirements contained in relevant applied standards. It is imperative that the ground connection be reliably maintained to protect the patient and medical staff. Hospital-grade power cords and cordsets carry the "green dot" signifying that they have been designed and tested for grounding reliability, assembly integrity, strength and durability.

3.4.2 Protection against water damage

We recommend the use of water detectors to protect against any unnoticed water leakages.

3.4.3 Potentially explosive areas

The dialysis machine may not be operated in areas at risk of explosion.

3.5 Water supply

3.5.1 Quality of water and dialysate

The user must ensure that the water quality is continuously monitored.

The following requirements must be fulfilled for incoming water:

- Must be free from Mg⁺⁺ and Ca⁺⁺.
- Must have a pH value between 5 and 7.

Water and dialysate must comply with the country-specific standards, i.e.:

- ISO 13959
Water for haemodialysis and related therapies

- ISO 23500

Guidance for the preparation and quality management of fluids for haemodialysis and related therapies

- ISO 11663

Quality of dialysis fluid for haemodialysis and related therapies

3.5.2 Disposal of used fluids



Risk of infection due to backflow of contaminated fluids from the drain into the dialysis machine!

- Ensure air clearance between hemodialysis equipment waste connector and the drain (8 cm).



Pipe system may be damaged by corrosive fluids!

- Use adequate drainage piping materials.



Ensure sufficient drainage capacity!

3.6 Initial commissioning

Initial commissioning should be carried out by the responsible technical service.

3.7 Setting date and time

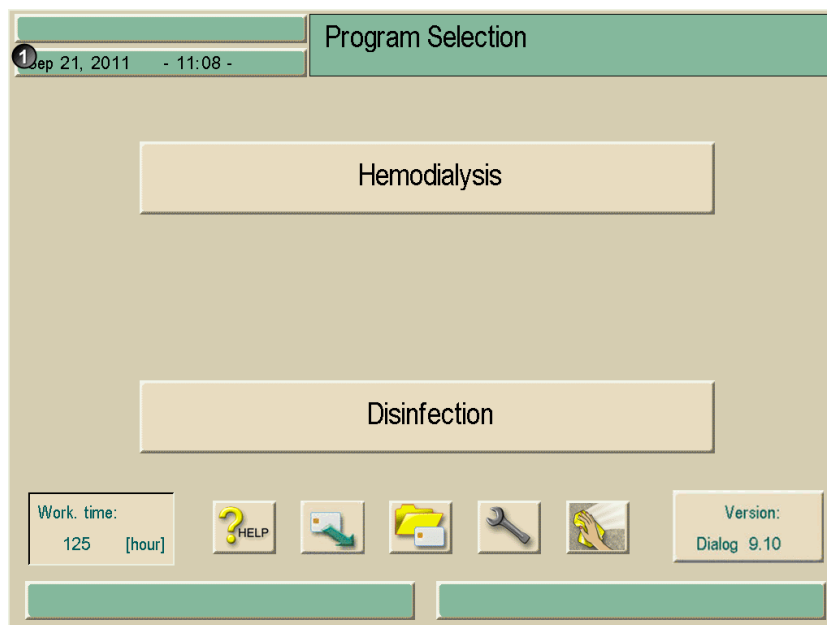
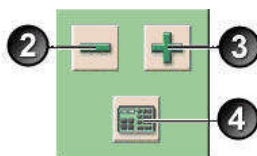

Fig. 3-3 Date and time



Setting date

- Touch field showing date and time 1.
- The field containing icons 2, 3 and 4 appears.
- There are two setting options:
 - To increase or decrease the date, change date with icons 2 and 3.
 - To enter the date using the keypad, touch icon 4.
- The numeric keypad appears on the screen.
- Enter date using keypad and confirm by selecting OK.

Setting time

- Touch field containing date and time 1.
- There are two setting options.
 - To increase or decrease time by minutes, change date with icons 2 and 3.
 - To enter the time using the keypad, touch icon 4.
- The numeric keypad appears on the screen.
- Enter date using keypad and confirm by selecting OK.
- Touch field containing date and time 1.
- The field containing 2, 3 and 4 disappears.
- The set date and time are displayed.

3.8 Switching on and off



- In case of any damage that may put into question the safe use of the machine, the dialysis machine must not be used. Inform customer service.
- Only switch on dialysis machine after it has reached room temperature.
- Observe requirements on installation site and water supply.

Switching on and off

- Press mains switch.

The dialysis machine switches from ON to OFF status or vice versa.

Accidental pressing of the mains switch

In case of accidentally switching off the dialysis machine by pressing the power switch during a dialysis session, proceed as follows:

- Press power switch again.

An alarm message is displayed on the screen, "System recovered", for interruptions less than 15 minutes, and the therapy continues.

- Confirm alarm by pressing "Confirm alarm".

In case of interruptions lasting no longer than 15 minutes, therapy continues. In case of longer interruptions, the dialysis machine switches to the therapy selection window.

In case of accidentally switching off the dialysis machine by actuating the power switch during disinfection, proceed as follows:

- Press the power switch again.

The disinfection process is continued.



In case of accidentally switching off the machine a characteristic signal rings out three times.

Table of contents

4	Therapy types	4-3
4.1	Hemodialysis (HD)	4-3
4.2	Phases of pure ultrafiltration	4-3
4.3	Methods of treatment	4-4
4.3.1	Double-needle procedure	4-4
4.3.2	Single-needle procedure	4-4
4.4	Effectiveness of dialysis (Kt/V)	4-5

4 Therapy types

4.1 Hemodialysis (HD)

Hemodialysis is the most common type of therapy used for cleaning blood. Depending on clinical requirements, treatment generally lasts between three and six hours (typically 4 hours). The procedure is carried out three times a week (in exceptional cases, twice a week).

Mode of operation

The dialysis machine pumps blood through a vascular access from the patient into the dialyzer.

Inside the dialyzer, metabolic waste products are separated from the blood. The dialyzer operates as a filter that is divided into two parts by a semipermeable membrane. On one side, the patient's blood is pumped past, on the other side the dialysate flows past.

During the therapy, the dialysate is prepared by the dialysis machine. It consists of prepared water to which certain quantities of electrolyte and bicarbonate, depending on the individual patient's requirements, are added.

The concentrations of electrolyte and bicarbonate in the dialysate are adjusted in such a way that certain substances can be removed from the blood through convection, diffusion and osmosis, while other substances are added at the same time. This is achieved mainly by diffusive clearance through the semipermeable membrane of the dialyzer. The dialysate transports the metabolic waste products from the dialyzer into the discharge line. The cleaned blood is then recycled back to the patient.

During treatment, the dialysis machine monitors blood circulation outside of the body, pumps blood and dialysate in separate circulation systems through the dialyzer and monitors the composition and volume balance of the dialysate.

The heparin pump, which is also part of the dialysis machine, is used to add anticoagulants to the blood so as to prevent the formation of blood clots.

In addition to cleaning metabolic waste from the blood, the dialysis machine removes water from the blood, which would be excreted through the kidney in healthy humans.

4.2 Phases of pure ultrafiltration

Phases of pure ultrafiltration are used for short-term extraction of a higher amount of fluid from the patient.

For further information see section 10.

Mode of operation

During phases of pure ultrafiltration no dialysate flows through the dialyzer. The purpose of this therapy is to extract fluid from the patient.

4.3 Methods of treatment

4.3.1 Double-needle procedure

The double-needle procedure is the standard technique in hemodialysis. Blood is extracted from the patient through the arterial vascular access. The blood pump continuously pumps the blood through the arterial tubing system to the dialyzer. There, the exchange of metabolic waste products between the blood and the dialysate proceeds through the semipermeable membrane of the dialyzer. After that, the blood is taken back through the venous tubing system, the bubble trap and a second vascular access to the vein.

4.3.2 Single-needle procedure

The single-needle procedure is applied when patients experience problems with the predominantly used double-needle dialysis. In the single-needle procedure only one needle (single-needle cannula) or a single-lumen, single-needle catheter is applied to the patient. The arterial and venous ends of the tubing system are connected via a Y-connector. This procedure allows reducing the number of punctures by half compared to double-needle dialysis, thus preserving the patient's shunt.

The single-needle clamp procedure allows ending a running double-needle dialysis in case of problems (e.g. at the shunt). The single-needle clamp procedure requires only one blood pump but can also be applied to a dialysis machine containing two pumps. The second blood pump remains switched off in this case. See chapter 9 for a complete description of the single-needle procedure.



Single-needle is not available with the use of Streamline® Bloodlines.

Mode of operation

The patient is connected through either a "standard AV set with 30 mL chamber" or an "AV set for SN clamp with a 100 mL chamber". The arterial and venous blood lines are connected through a Y-connector at the vascular access.

With the venous tube clamp closed and the arterial tube clamp (if present) open, the blood pump pumps blood from the patient through the dialyzer into the venous chamber. The pressure in the venous chamber is monitored via the venous pressure absorber. As soon as the preset upper switching pressure is reached, the blood pump is switched off and the venous tube clamp opens. If an arterial tube clamp is installed also, this clamp closes and thereby blocks any recirculation of blood into the arterial tube between Y-connector and blood pump.

Due to the pressure in the venous chamber, the blood flows through the dialyzer back to the patient until the lower switching pressure is reached. Once the lower switching pressure has been reached in the venous chamber, or the preset return flow time has expired, the venous tube clamp closes. Shortly afterwards the arterial tube clamp (if present) opens. The blood pump is activated and the process starts again with the withdrawal of blood from the patient.

The return flow time is averaged over the first three cycles and automatically set between 3 and 10 seconds for the duration of the therapy. If the lower switching pressure was not reached, the machine switches to the arterial phase after 10 seconds.

4.4 Effectiveness of dialysis (Kt/V)



If the theoretical calculation of the effectiveness is selected, the option Adimea™ as described in chapter 10.4 is not applicable.

The dialysis machine allows optimization of therapy over many treatments. For this purpose, the theoretical effectiveness is calculated by the dialysis machine. This theoretical figure can then be compared with the actual effectiveness determined from blood samples.

For actual effectiveness, patient urea values before and after dialysis have to be determined in the laboratory and entered into the dialysis machine. (Only available while using therapy card system.)

Comparison of theoretical and actual effectiveness over many treatments

The comparison of theoretical and actual effectiveness can be used as a decision aid for setting the therapy parameters and for selecting the dialyzer. Using the patient therapy card, the dialysis machine can store and list the figures for the last 50 treatments.



WARNING

Risk to the patient by the input of new treatment parameters.

- The treatment parameters may not be determined solely on the basis of the measured Kt/V.
- A measurement of the Kt/V does not replace the therapy prescribed by the physician.

Monitoring the effectiveness during the current treatment

During a treatment, the current effectiveness estimated by the dialysis machine can also be used as an indicator for the effectiveness that would be achieved if the treatment would be terminated at a specific time.

The warning during treatment that a certain target value for the effectiveness (Kt/V value), which was determined prior to treatment, cannot be reached, allows early corrective intervention into the running treatment.



It cannot be guaranteed that the calculated Kt/V value will actually be reached.

Calculation during particular phases

The Kt/V value is **not** calculated during:

- Sequential phases of profiles
- Hemofiltration
- Infusion bolus, as the actual blood flow does not correspond to the blood pump speed

During a phase at a min. UF rate, the Kt/V value calculation is continued. During a single-needle dialysis, the Kt/V value calculation is based on the average blood flow.

Table of contents

5	Preparing for hemodialysis	5-3
5.1	Initiating hemodialysis.....	5-4
5.2	Automatic test.....	5-4
5.2.1	Operation during automatic test.....	5-5
5.2.2	Terminating the automatic test sequence.....	5-6
5.2.3	Completion of automatic test sequence	5-6
5.3	Reducing the warning sounds during preparation.....	5-6
5.4	Connecting the concentrate	5-8
5.5	Setting the rinsing parameters.....	5-9
5.6	Inserting, rinsing and testing the tubing system.....	5-11
5.6.1	Inserting standard A/V tubing.....	5-12
5.6.2	Rinsing and testing standard A/V tubing.....	5-14
5.6.3	Level regulation during Preparation (if present).....	5-14
5.6.4	Inserting Streamline® bloodline.....	5-16
5.6.5	Rinsing and testing the tubing system.....	5-17
5.7	Preparing the heparin pump	5-18
5.7.1	Inserting the heparin syringe.....	5-18
5.7.2	Venting the heparin line	5-19
5.8	Setting the treatment parameters	5-20
5.8.1	Setting the dialysate parameters	5-21
5.8.2	Monitoring the dialysate	5-24
5.8.3	Sampling of dialysate for microbiology analysis	5-25
5.8.4	Setting the ultrafiltration parameters	5-27
5.8.5	Setting the pressure limits	5-29
5.8.6	Setting the heparin parameters.....	5-31
5.9	Rinsing the dialyzer	5-33
5.9.1	Rinsing the dialyzer using standard A/V tubing.....	5-33
5.9.2	Rinsing the dialyzer using Streamline® bloodline	5-34
5.10	Stand-by mode	5-35
5.10.1	Activating the stand-by mode	5-35
5.10.2	Switching off the stand-by mode	5-35
5.11	Power failure in preparation.....	5-36
5.12	Changing the bicarbonate cartridge during preparation.....	5-36

5 Preparing for hemodialysis



Safety air detector (SAD) not active! Danger of air embolism!

- Do not connect the patient out of the "Therapy" phase, e. g. during "Preparation/Disinfection" phase!
- Do not use the blood pump for infusion outside the "Therapy" phase, e.g. during the saline infusion.



Hemodialysis is the standard dialysis procedure for all system variants. The procedure is the same for all system variants.

5



Loss of blood or damage of blood by temperature, pressure or wrong composition of dialysis fluid!

- Ensure that the patient will only be connected in the "Therapy" phase.
- Do not have the patient connected in any other phase but the "Therapy" phase, e.g. during the "Preparation/Disinfection" phase!
- Do not use the blood pump for infusion outside the "Therapy" phase, e.g. during the saline infusion.



Connecting the patient in "Preparation/Disinfection" generates an alarm by the red detector. This results in the blood pump stopping and SAKV closing.



Risk to the patient due to blood loss.

When the blood flow stops, because of blood pump failure during loss of mains power, blood clotting could cause blood loss.

- Return blood to patient manually (see chapter 13.4.).

5.1 Initiating hemodialysis

After switch-on, the following main screen is displayed on the dialysis machine:

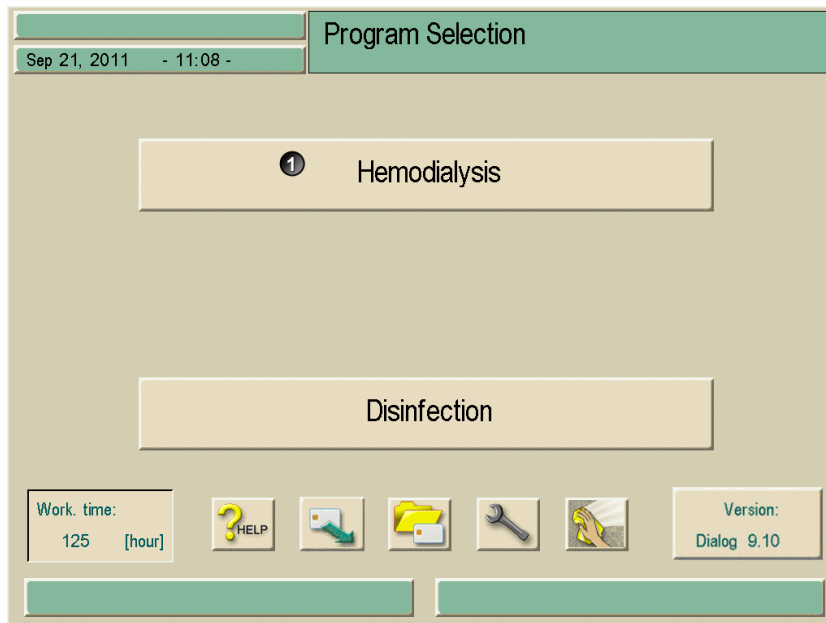

Fig. 5-1 "Hemodialysis" main screen

➤ Touch field 1.

The first preparation screen for hemodialysis appears. The dialysis machine starts an automatic test sequence.

5.2 Automatic test

At the automatic test stage, the dialysis machine automatically checks all control functions relevant to the safety of the machine.

i While the dialysis machine is carrying out automatic tests, you can begin entering the treatment parameters.

i If the option "Bloodside pressure test with pressure compensation" is activated in TSM the excess pressure in the A/V system will be dissipated through the dialyzer after the pressure test on the blood side.
Depending on the type of dialyzer used, this may take up to two minutes.

5.2.1 Operation during automatic test

Legend

- 1 Status field
- 2 Operating field

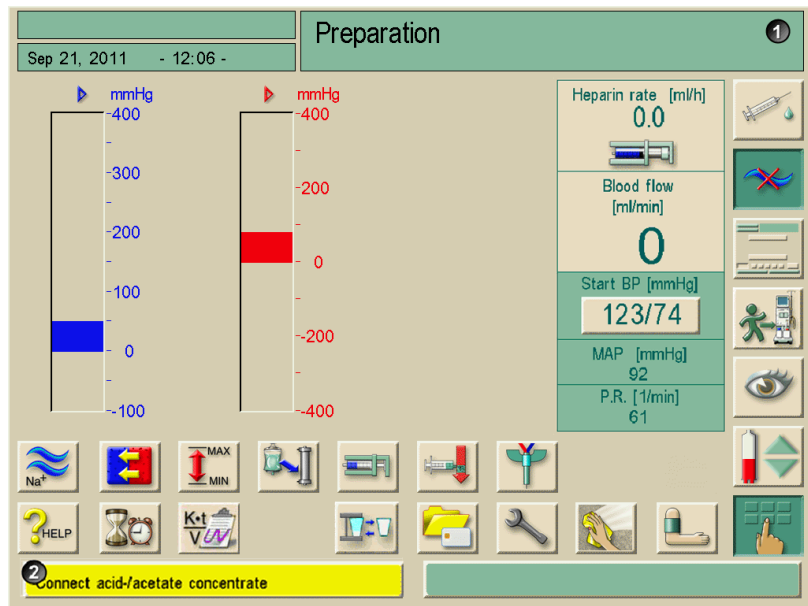

Fig. 5-2 First preparation screen "Hemodialysis"

While the dialysis machine goes through the automatic test sequence, messages on a yellow background appear in field 2 if the machine expects you to carry out actions, such as connecting the concentrate. The test sequence is continued once this action has been completed.

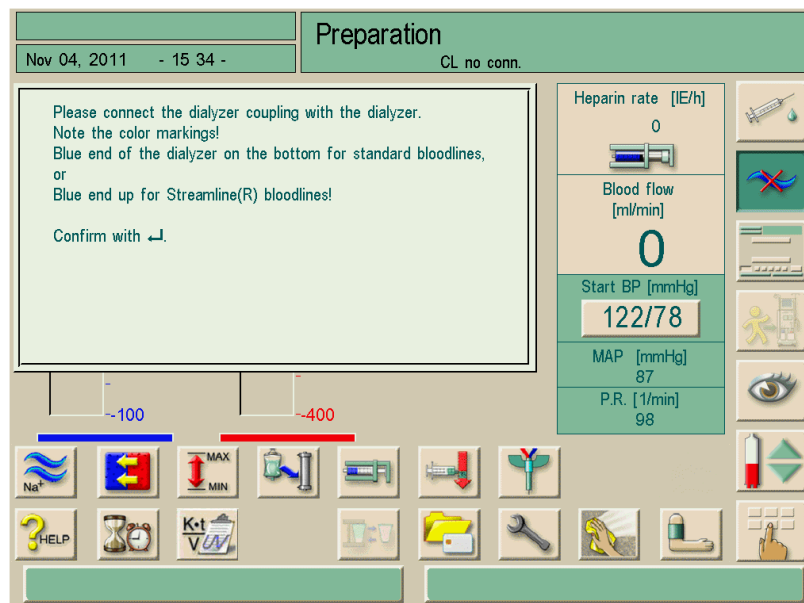

Fig. 5-3 Information window during automatic test

Information windows can be hidden by a touch for approx. 20 seconds while you use the screen for other actions, e.g. entering parameters. Upon completion of the entry, the information window will reappear. Saving the data with the Enter ↵ button will only be possible after confirming the information window.

5.2.2 Terminating the automatic test sequence



➤ Touch icon.

The automatic test sequence is terminated.

The options "Return to therapy selection" and "Repeat blood-side tests" are displayed.

➤ Touch the appropriate field.

5.2.3 Completion of automatic test sequence



This icon is enabled as soon as the dialysis machine has completed all automatic tests and the bloodline tests.



In case of use of dialyzers packed with germicide, the rinse program should be completed and the dialyzer tested for residual sterilant prior to changing to the therapy phase.

5.3 Reducing the warning sounds during preparation

For the user there is a possibility to suppress some warning sounds during preparation. Warning sounds during preparation which require interaction with the user may not be suppressed. Examples of these warning sounds are fault removal or on demand for action. Optical alarms and the fault finding are not affected.

The function "Reduced warning sounds during preparation" can be used for the following warnings.

ID	Text
1927	Rinsing volume attained
1928	Filling volume is reached
1112	UF Rinse volume for dialyzer too high
1153	Repeat self test!
1033	Temperature too low
1034	Temperature too high
1038	Connect acid/acetate concentrate
1040	Connect bicarbonate
1041	Connect blue concentrate coupling to rinse bridge
1045	Bicarbonate cartridge holder open



Preparing the machine with reduced warning sounds could cause a delay of the treatment. Scheduling planned preparation time requires increased attention of the staff.

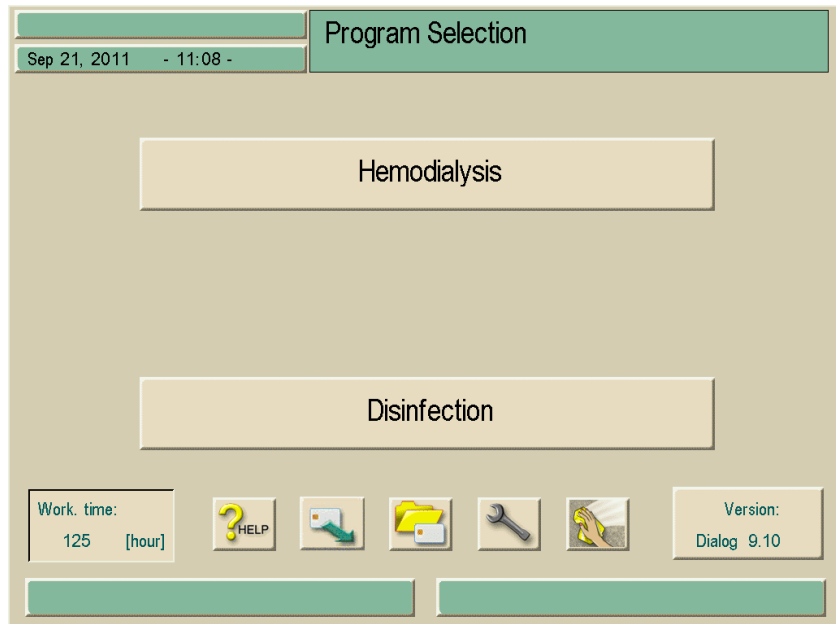

Fig. 5-4 "Hemodialysis" main screen



- Touch icon at main screen.
The following screen is displayed:

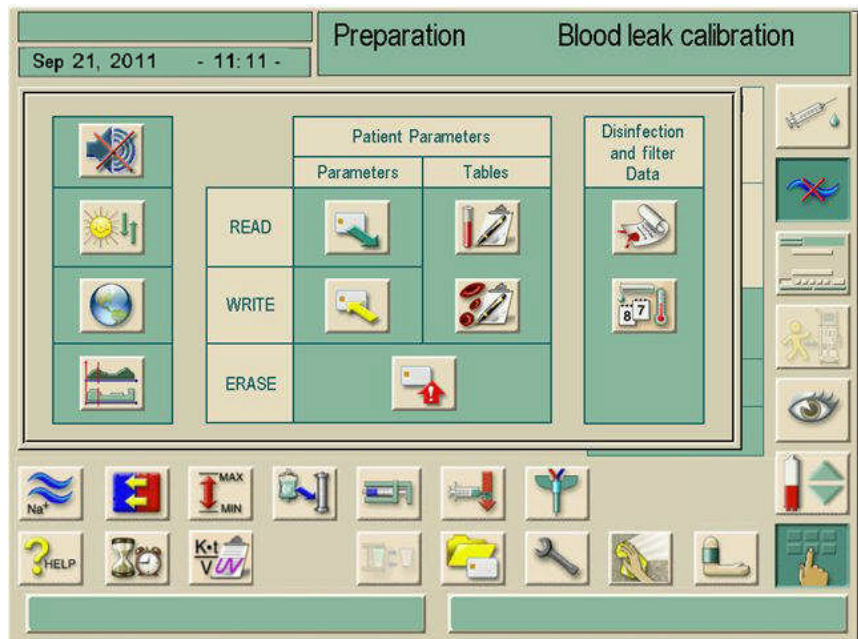

Fig. 5-5 Screen for suppression of acoustic Signals



- Touch icon.

If a function is not active (icon background not colored in green) it may be activated by touching the icon. The warning sounds listed in the table above are automatically suppressed. To indicate this, a crossed out speaker symbol appears at the date line of the screen.



Fig. 5-6 Date line with suppressed acoustic signal

5

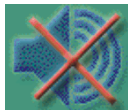

Now the icon is shown as active (green colored background).

Touching the icon once more inactivates the function and turns on audible signals for the warning sounds listed above. The indicator at the date line disappears.

The function "Reduced warning sounds during preparation" could be preset in the TSM-mode by a technician.

The function "Reduced warning sounds during preparation" is only available during program selection and preparation and can be configured during selection of program and preparation. For all other phases of treatment this function is not available (icon appears grey). Changing into the next therapy the function automatically set resets to the TSM-preadjustment.

5.4 Connecting the concentrate

On completion of the internal pressure test, the request **connect acetate/acid concentrate** appears on a yellow background.



Risk to the patient due to incorrect composition of dialysate!

- Ensure that the correct concentrates are provided for the intended therapy.
- Only use concentrates whose printed use-by date has not expired.
- Only use originally closed and intact concentrate containers.
- Observe storage information on concentrate containers.
- It is recommended to use concentrates produced by B. Braun Medical Inc.
- When concentrates are used that are not produced by B. Braun Medical Inc. the correct mixing ratio and composition has to be checked on the concentrate label.

i

The physician in charge is responsible for determining the concentrates to be used.

For bicarbonate dialysis:

- Insert red concentrate rod into the canister containing acidic bicarbonate concentrate, e.g. SW 325A.
- Insert blue concentrate rod into the canister containing alkaline bicarbonate concentrate, e.g. bicarbonate-containing solution 8.4%.
The dialysis machine continues the automatic test sequence.

For acetate dialysis:

- Place concentrate rod marked in red and white into container filled with acetate concentrate, e.g. SW 44.
- Leave blue concentrate rod in blue concentrate rod holder.
The dialysis machine continues the automatic test sequence.

5.5 Setting the rinsing parameters

This option allows rinsing of the dialyzer membrane with or without ultrafiltration.

To call up simultaneous ultrafiltration:

- Touch icon in preparation window.
The rinsing parameters are displayed.

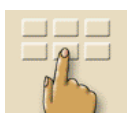

Preparation		Acknowledge data!	
Sep 21, 2011 - 11:11 -			
1 AV system filling/rinsing		2 Setting	Remaining
Filling BP rate	[ml/min]	100	
Filling BP volume	[ml]	3 700	700
4 Rinsing with ultrafiltration		5 Setting	Remaining
Rinsing BP rate	[ml/min]	200	
Dialysate flow	[ml/min]	6 500	
Rinsing time	[min]	7 59	59
UF rate for rinsing	[ml/h]	8 203	
UF-volume f. rinsing	[ml]	9 200	200
10 Blood flow for connecting patient	[ml/min]	100	
? HELP		O.K.	
		Blood flow [ml/min] 100 Start BP [mmHg] 12 1/80 MAP [mmHg] 92 P.R. [1/min] 90	
Ack. data before connecting patient			

Fig. 5-7 "Rinsing parameters" screen

- Set the values intended for rinsing parameters according to dialyzer manufacturer recommendations and the table below.

Item	Text	Range	Description
1	AV system filling/rinsing	-	Rinse blood side
2	Filling BP rate	50 – 600 mL/min	The rate with which the blood side is filled or rinsed
3	Filling BP volume	0 – 6000 mL	The blood pump stops after it has rinsed the blood side using the set volume
4	Rinsing with ultrafiltration	-	Rinsing of dialyzer membrane
5	Rinsing BP rate	50 – 300 mL/min	BP rate for rinsing program
6	Dialysate flow	300 – 800 mL/min	DF rate for rinsing program
7	Rinsing time	0 – 59 min	Duration of adjusted rinsing program
8	UF rate for rinsing	0 – 3000 mL/h when rinsing with a physiological saline solution	-
9	UF-volume f. rinsing	0 – 2950 mL when rinsing with a physiological saline solution	-
10	Blood flow for connecting patient	50 – 600 mL/min	-

- Confirm all settings by pressing the O.K. icon.
The initial preparation window reappears, at the end of the chosen rinsing time the yellow signal lamp flashes.

5.6 Inserting, rinsing and testing the tubing system



The used blood pump tubing segment in the AV system must have the dimensions 8 x 12 mm (inner/outer dimension).



Risk to patient due to incompatibility of tubing system and dialysis machine!

- Only use disposables supplied by B. Braun Medical Inc.



Risk to patient due to hemolysis or blood loss when using a faulty blood tubing system!

- Check to ensure that the tubing system is not damaged.
- Check to ensure that no line is kinked.
- Make certain that all connections are tightly sealed.



Risk to patient due to infection as a result of contamination of the transducer protector on the tubing system!

- Replace the machine-side transducer protector if it has been contaminated with blood.
- Instruct technical service to replace transducer protector, tubing and pressure port.
- Execute disinfection after replacement.
- Only use the machine again when the filter has been changed.



Risk of contamination at the patient connectors on the blood tubing system when using a rinsing bucket!

- Ensure aseptic technique in handling of the blood lines.

5.6.1 Inserting standard A/V tubing

Legend

- 1 Venous tubing valve
- 2 Safety air detector with venous red detector
- 3 Venous chamber
- 4 Venous pressure transducer
- 5 Arterial pressure transducer
- 6 Arterial blood pump
- 7 Heparin pump
- 8 PBE-Pressure transducer for arterial entry pressure at the dialysis machine (option)
- 9 Arterial chamber
- 10 Dialyzer

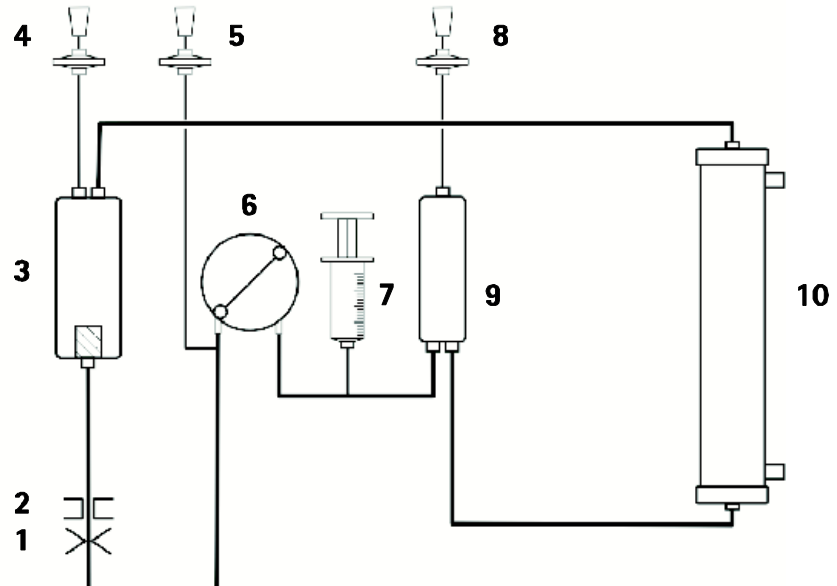

Fig. 5-8 Schematic view of extracorporeal circulation system used in hemodialysis



A dialyzer holder that can be attached to the infusion pole above the top fixture is available as an accessory.



To swivel or shift the dialyzer holder, always loosen the screw clamp on the infusion pole so that the latter will not be damaged.

- Fix dialyzer in dialyzer holder.
- Attach bag containing physiological saline solution (up to 2.5 kg) to infusion pole.
- Connect arterial connection of blood tubing system to bag containing the physiological saline solution. Do not break the seal yet.
- If present: Connect pressure measuring line for arterial pressure to the PA pressure sensor.
- Open lid (left, if using a double pump dialysis machine) of blood pump.
- Insert tubing end with patient supply into the matching opening of the rotor.
- Turn rotor in direction of arrow to thread blood pump segment into pump.



CAUTION

Risk to patient due to blood loss when using a faulty blood tubing system!

- Check to ensure that the tubing system and pump segments are not being damaged at insertion.
- Check to ensure the pump segment is fully inserted into the respective tubing guide at the blood pump.
- When inserting the pump segments do not rotate the rollers against a drag.
- If the tubing system has been damaged through the insertion, replace it with a new one.

- Close lid (left) of blood pump



The spacers on the inside of the lid are not designed for placement of the pump segment in the right position. They prevent the pump segment from moving out of the proper position during operation therefore preventing only damage to the rollers.

- Connect pressure transducer connector (if present), to PBE sensor connection.
- Connect arterial and venous tubing system to dialyzer, observing color-coding. Do not yet remove the stops on the lateral Hansen connectors.
- Connect pressure measuring line for venous pressure to PV pressure sensor, making certain the pressure measuring line is not kinked and the filter is securely seated.
- Insert venous bubble trap into fixture.
- Open lid of air detector.
- Insert tubing into air detector and close lid.
- Connect venous patient connection to the rinse bucket.
- Insert blood tubing system into fixtures.



CAUTION

Risk of damage to the tubing system due to prolonged clamping of the venous blood line!

- **Only place the venous blood line into the tubing clamp (SAK) on therapy day.**



If a tubing system without PBE sensor is used, the message "PBE not connected" is displayed during the pressure test.

The message automatically disappears after 60 seconds.



Risk of contamination of the priming bag if administration set is connected and blood side pressure test fails because of a wet transducer protector membrane!

- Set level in the drip chamber of the administration set.
- If there is no air inside the drip chamber, change priming bag because of possible contamination.
- Change priming bag in case of blood side pressure test failure.

5.6.2 Rinsing and testing standard A/V tubing

- Break the seal of the bag containing physiological saline solution.
- Start the blood pump by pressing the + button on the keypad.

The tubing system will fill with physiological saline solution. The blood side of the dialysis circuit is rinsed and automatically tested for any leakages.

During the priming procedure, both the arterial and venous patient connection lines can be placed in the holders located on the inside top of the rinse bucket. Lines should be placed to prevent the ends from touching the waste product with both vented end caps intact.

Prior to patient connection, if fresh saline is to replace the recirculated saline, the arterial line can be held above the rinse bucket, being careful not to touch the bucket. Once the saline in the arterial portion of the line is replaced, it may be connected to the patient but left clamped. The venous blood line may be placed in the line holder in the bucket with the vented end cap in place to prevent contamination of the patient connection during saline replacement. After the treatment has been initiated, the rinse bucket should be emptied and rinsed with clean water and returned to the machine.

5.6.3 Level regulation during Preparation (if present)

The level regulation system allows the user to set saline levels in the blood line chambers for preparation by screen touch.



- During Preparation the levels can only be set while the blood pump is running.
- The user is obligated to check for correct setting of the levels in the chambers.

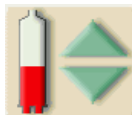

- Touch icon
The level window opens.

Legend

- 1 PV - Venous chamber
- 2 PBE – Arterial blood entry chamber

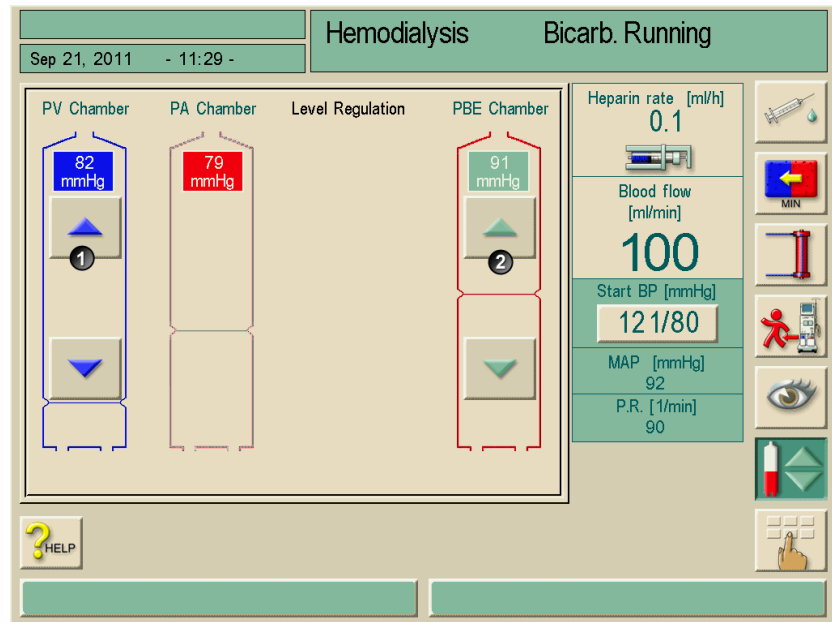

Fig. 5-9 Level regulation screen (if present)

The setting of the following chambers is possible:

- Venous chamber (PV) (1): the button is always active.
- Arterial blood entry chamber (PBE) (2): the button is always active (if selected in TSM).

i

The adjustment of the PBE chamber is only possible if an AV system with PBE line is used and the line is connected to the machine.



Level increasing

- Touch icon gently with one touch.
- Observe level.
- Touch again for the correct setting if necessary.



Level decreasing

- Touch icon gently with one touch.
- Observe level.
- Touch again for the correct setting if necessary.



- To leave the level regulation function, touch icon again.

5.6.4 Inserting Streamline[®] bloodline

For further information about the use of Streamline[®] bloodline, please refer to the instructions for use provided by the manufacturer.

- Remove lines from pouch.
- Take blue venous blood line in hand.
- Remove the line tape.
- Place venous patient connector into rinse receptacle, do not close any clamps or open any end caps.
- Remove the dialyzer from its holder to connect the venous dialyzer connector end to prevent kinking the line where it joins the pod. Try to have the venous pod facing forward for better visualization and to prevent kinking the monitor line.
- Connect the venous pod monitoring line to the VP monitor site.
- Place the venous drip chamber into the chamber holder.
- Position the venous line into the air detector housing and venous line clamp.
- Close air detector housing door firmly.
- Take red arterial line in hand.
- Remove large line tape leaving the small infusion line tape in place. Place the patient connector into the rinse receptacle, clamping nothing. End caps are vented for easy priming without contamination.
- Place the arterial pod below the left lower end of the blood pump housing and turn the blood pump until the blood pump segment is caught but not occluded.
- Untape the infusion line and spike saline with all clamps open.
- Prime the arterial line and heparin line by gravity expelling air from both the arterial patient connector end and dialyzer end of the tubing. Clamp large red line clamp.
- Clamp upper saline infusion line clamp.
- Clamp the heparin infusion line located to the right of the blood pump.
- Connect dialyzer end to the dialyzer, unclamp upper saline infusion line clamp and finish loading the blood pump segment by hand.
- Close blood pump door and connect the arterial pod monitor line to the AP monitor site. No transducer protector is needed. Inspect lines and pods for position and kinking.

5.6.5 Rinsing and testing the tubing system

- Increase blood pump speed as per dialyzer manufacturer recommendations to complete priming.
- Once the saline has filled the venous blood line past the drip chamber, open the vent line at the top of the drip chamber and fill the chamber and the vent line completely. Clamp the vent line.
- When the blood pump stops, connect the arterial and venous patient ends for recirculation and restart the blood pump. The membrane inside the pods should be moving slightly when the blood pump is running. The faster the blood pump speed, the more movement.

i

-
- Medication administration sites: On the saline infusion line there is one Locksite® and one injection port.
 - The venous drip chamber has the standard luer-lock connector for medication administration but caution must be used to avoid introduction of air into the system.
 - The arterial line has a locksite located near the patient connection, but this is usually used for blood draws rather than medication administration.
 - PBE cannot be utilized with Streamline® bloodlines.
 - Single needle cannot be performed using Streamline bloodlines.
 - See the Trouble Shooting Guide if blood side testing fails due to misaligned pod diaphragm.
-

5.7 Preparing the heparin pump

The heparin pump is suitable for tubing systems with heparinization downstream of the blood pump in the positive pressure region.

5.7.1 Inserting the heparin syringe

Legend

- 1 Syringe bracket
- 2 Syringe gripping plate
- 3 Clip
- 4 Unlocking lever
- 5 Syringe stop

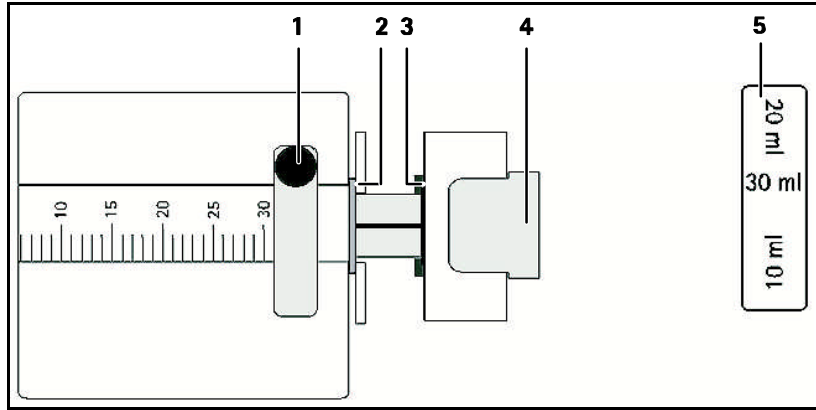

Fig. 5-10 Heparin syringe

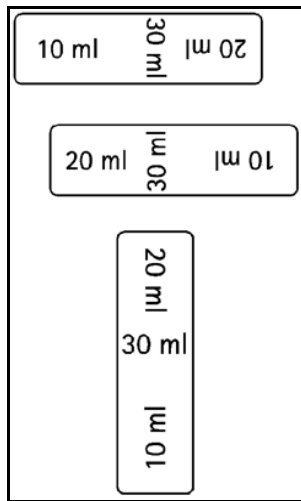

Fig. 5-11 Position of the syringe stop depending on syringe size

- Set syringe stop (5) in such a way that the syringe size can be read.
- Release unlocking lever (4) and pull out drive mechanism.
- Lift and turn syringe bow (1).
- Insert syringe in such a way that grip and pressure plate engage in the guide.
- If the syringe was inserted correctly, the unlocking mechanism will jump back automatically. Do not close the unlocking mechanism manually.
- Close syringe bracket.

5.7.2 Venting the heparin line

- Before inserting the syringe, manually vent heparin line.
- or
- Vent heparin line prior to starting the dialysis by providing a heparin bolus.

5.8 Setting the treatment parameters

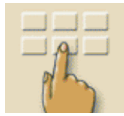

➤ Touch icon in preparation window.
A line of additional icons (1) is displayed.

5

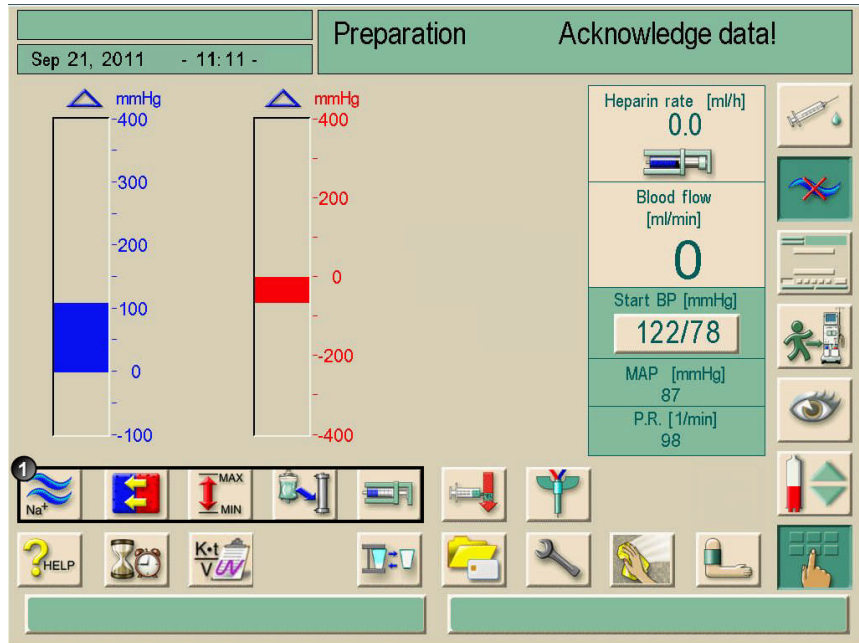
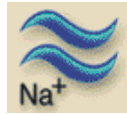

Fig. 5-12 Preparation window "Parameters"

Icon reference:

Icon	Parameter group	Reference
	Dialysate parameters	Page 5-21
	Ultrafiltration parameters	Page 5-21
	Pressure limit settings	Page 5-29
	Heparinization data	Page 5-31

5.8.1 Setting the dialysate parameters



➤ Touch icon in preparation window.

If Acetate is activated in TSM, the following dialysate parameters are displayed.

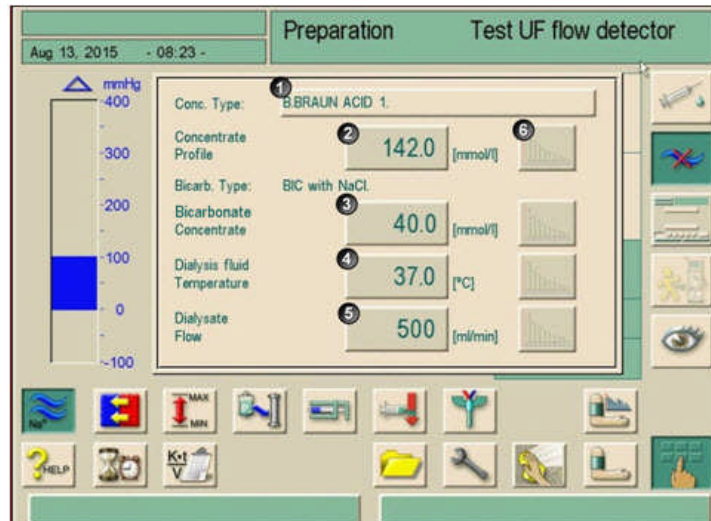

Fig. 5-13 "Dialysate parameters" screen (if acetate is activated in TSM)

➤ Set dialysate parameters according to the following table.

Item	Text	Range	Description
1	Conductivity	12.5–16.0 mS/cm in steps of 0.1 mS/cm (approx. 125–160 mmol/L)	–
2	Bicarbonate	–	Dialysis with an acidic bicarbonate hemodialysis concentrate and an alkaline bicarbonate hemodialysis concentrate formulation
3	Acetate	–	Dialysis with acetate concentrate
4	Bicarbonate Conductivity	2–4 mS/cm in steps of 0.1 mS/cm (approx. 20–40 mmol/L)	–
5	Dialysis fluid Temperature	33–40 °C in steps of 0.5 °C or manual entry in steps of 0.1 °C / 91–104 °F in steps of 0.9 °F or manual entry in steps of 0.1 °F	–
6	Dialysate Flow	300–800 mL/min continuously adjustable	–
7	Profiles	–	Alternatively, profiles can be selected for the respective parameter, see section 11.2.

If dialysate measuring mode is set to mmol/l in TSM, the following dialysate parameters are displayed.

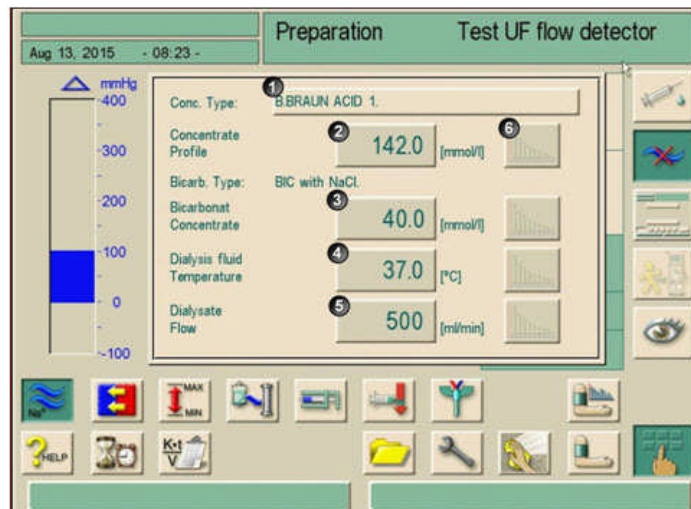

Fig. 5-14 "Dialysate parameters" screen (if acetate is deactivated in TSM)

➤ Set dialysate parameters according to the following table.

Item	Text	Range	Description
1	Conc. Type	- B. BRAUN ACID 1 - B. BRAUN ACID 2 - ... - B. BRAUN ACID 10	The mmol mode activates the list of concentrates. The default concentrate type is preselected in TSM.
2	Concentrate Profile	125.0 – 160.0 mmol/L in steps of 0.1 mmol/L (approx. 12.5 – 16.0 mS/cm)	The mmol mode is selected in TSM.
3	Bicarbonate Conductivity	20–40 mmol/L in steps of 0.1 mmol/L (approx. 2–4 mS/cm in steps of 0.1 mS/cm)	The mmol mode is selected in TSM.
4	Dialysis fluid Temperature	33–40 °C in steps of 0.5 °C or manual entry in steps of 0.1 °C 91–104 °F in steps of 0.9 °F or manual entry in steps of 0.1 °F	-
5	Dialysate Flow	300–800 mL/min continuously adjustable	-
6	Profiles	-	Alternatively, profiles can be selected for the respective parameter, see section 11.2.

i

The actual temperature at the dialyzer may differ marginally from the before adjusted temperature.

**Risk to the patient due to incorrect composition of dialysate!**

- Ensure that the correct concentrates are provided for the intended therapy.
- Use only concentrates whose printed use-by date has not expired.
- Observe storage information on concentrate containers.
- When using ml/mol mode, the user must select the proper concentrate type in accordance to the prescription.

**There may be a risk of uncontrolled UF withdrawal from patient due to a calcified dialysis fluid filter.**

- To prevent this, perform decalcification with citric acid 50% after each treatment.
- Alternatively, the automatic descaling function can be performed after each treatment if activated in TSM.

i

- The physician in charge is responsible for determining the concentrates to be used.
- The bicarbonate and acetate mode can be preset in the service program by technical service.
- Technical service can use the service program to set the limit value for mixing ratio monitoring in such a way that acetate dialysis cannot be performed.
- If the setting mmol has been selected in the service program, up to 10 acetate and bicarbonate concentrates can be preselected. An additional field with the name of the selected concentrate is displayed. Upon touching this field, a list of all available concentrates is displayed.
- If bicarbonate cartridges are used, see section 10.2.

5.8.2 Monitoring the dialysate

The displayed value for conductivity is a measure of the total electrolytes only. A measurement of the pH must be performed prior to each treatment to verify that the pH is within range of *6.9-7.6. Once the machine completes the blood side self tests measure the pH using an approved test method.

Recommended therapeutic ranges

pH	6.9 – 7.6
HCO ₃ ⁻	25–38 mmol/L

(The pH required by the AAMI RD 52:2004 standard is 6.9-7.6.)

 CAUTION	<p>Damage to machine due to calcium depositions at pH value >7.5 during bicarbonate dialysis!</p> <p>➤ Observe the measured pH value.</p>
--	--

	<p>pH values may be less accurate once the Dialog⁺ machine has initiated the stand-by mode as there is no dialysate flow to the dialyzer.</p>
--	--

	<p>Routine laboratory analysis of the total dialysate concentration in relation to the displayed conductivity should be incorporated into the local clinic's policies and procedures.</p> <p>*ANSI/AAMI RD52:2004</p>
---	---

5.8.3 Sampling of dialysate for microbiology analysis

Samples of the dialysate can be taken regularly in order to perform hygienic inspections. Since quantities > 100 mL are frequently required, these should not be taken during treatment.

Proceed as follows to take such a sample:

- Prepare the equipment.
- Put on mask and gloves.
- Disinfect the injection socket in the sample port with alcohol and let dry.
- Wait for the machine to complete the blood side self test.
- Slowly withdraw a 30 cc sample with the Luer syringe and discard.
- Slowly withdraw a 30 cc sample with the Luer syringe.
- Place the sample taken into a suitable container. Avoid contact with the container.

i

Sampling of dialysate is recommended by AAMI RD52:2014.

Legend

- 1 Sample port with injection socket

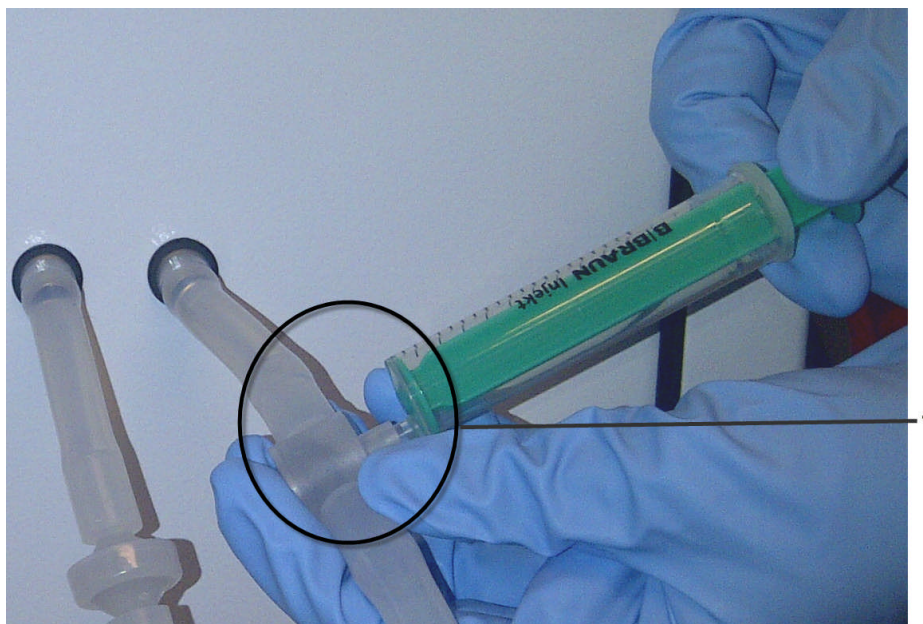

Fig. 5-15 Sample port



Risk to patient due to UF deviation when the sample port leaks.

- Ensure that the sample port does not leak after use.
- Install the sample port according to the enclosed installation instructions.
- Fluid leakages from the sample port cause an increase in weight reduction.
- Check the sample port for air inlet.
If necessary, remove the air.



Risk to patient due to contamination.

- **Do not use the sample port for rinsing the extracorporeal circulation.**
- Do not connect the arterial line for reinfusion to the sample port.
- Only use sterile syringes.



Risk to the patient due to incorrect composition of dialysate.

When the dialysate flow is stopped, the samples taken could provide incorrect measuring results.

- **Always perform sampling during therapy in the main connection, never in the bypass!**
- Use only calibrated measuring equipment.
- Do not perform sampling during disinfection.

5.8.4 Setting the ultrafiltration parameters



- Touch icon in preparation window.
The ultrafiltration parameters will be displayed.

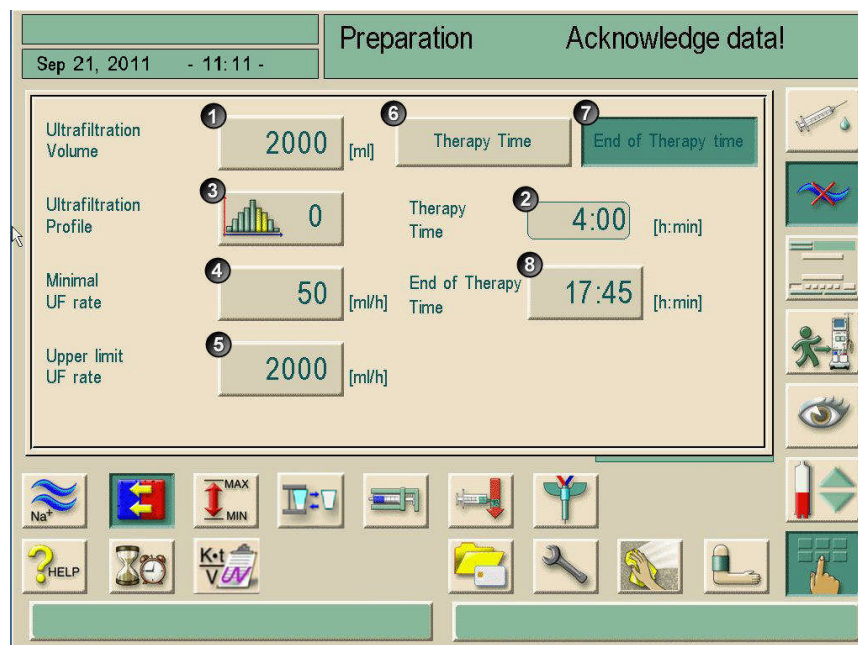

Fig. 5-16 "Ultrafiltration parameters" screen

- Set ultrafiltration parameters according to the below table.

Item	Text	Range	Description
1	Ultrafiltration Volume	100–20000 mL	
2	Therapy Time	10 min–10 h	Therapy time
3	Ultrafiltration Profile		For selecting an ultrafiltration profile or choosing sequential therapy, see section 10.3
4	Minimal UF rate	0–500 mL/h	Min. ultrafiltration rate
5	Up. limit UF rate	0–4000 mL/h	Max. ultrafiltration rate
6	Button to set therapy time		The therapy time can be set. The end of therapy time is calculated.
7	Button to set end of therapy time.		
8	End of therapy time		The absolute end of therapy time is indicated.

Set the therapy time

➤ Touch buttons 6 and 2 in Fig. 5-15.

Set value by + / - or use the keypad to enter the value.

Set the absolute end of therapy time

➤ Touch buttons 7 and 8 in Fig. 5-15.

Legend

- 1 Ultrafiltration Volume
- 2 Therapy Time
- 3 Ultrafiltration Profile
- 4 Minimal UF rate
- 5 Up. limit UF rate
- 6 Button to set therapy time
- 7 Button to set End of Therapy time.
- 8 End of Therapy time

5

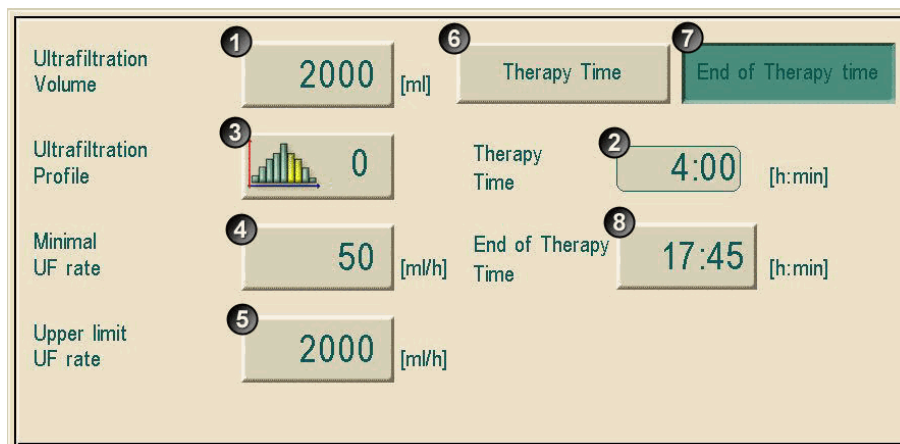

Fig. 5-17 Ultrafiltration parameters

A keypad will open. The end of therapy time can be set in a time range considering the ultrafiltration volume, the minimal UF rate and the upper limit UF rate.



Fig. 5-18 Set End of Therapy time

The effective therapy time is calculated as the difference between the set end of therapy time and the current time.

! The set end of therapy time will not be extended by Bypass phases.

! It is always possible to change back to set the therapy time.

! To avoid alarms, adjust the upper limit for the ultrafiltration rate to value above the calculated actual ultrafiltration rate.

! Selecting low UF-rates with long UF-time can cause deviation between debit value and actual value. Corresponding warnings will appear on the screen. The deviation will be indicated and has to be confirmed by the user pressing the Enter button ↵

5.8.5 Setting the pressure limits

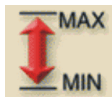

➤ Touch icon in preparation window.
The pressure limit values will be displayed.

Preparation		Acknowledge data!	
Sep 21, 2011 - 11:11 -			
1 Limit delta Min/Max. PA	70	70	[mmHg]
Actual PBE	199		[mmHg]
Max/Delta Pressure:	700	150	[mmHg]
2 Actual/ TMP TMP	140	350	[mmHg]
3 Limits TMP	LIMIT OFF	40	40 Low/High [%]
5 Extended TMP-limit range			
Heparin rate [ml/h]		0.0	
Blood flow [ml/min]		0	
Start BP [mmHg]		122/78	
MAP [mmHg]		87	
P.R. [1/min]		98	

Fig. 5-19 "Pressure limits" screen

➤ Set pressure limits according to the below table.

Item	Text	Range	Description
1	Limit delta Min./Max. PA	10 – 100 mmHg	Limits window for arterial entry pressure PA. Distance to min. and max. PA
2	Actual TMP/ maximum TMP	300 – 700 mmHg	Max. TMP: see information provided by dialyzer manufacturer
3	Limits TMP	ON/OFF	Monitoring the TMP at the dialyzer
4	Low/High	2 – 99 %	Limits window for TMP in % of actual value
5	Extended TMP-limit range	ON/OFF	The TMP limits enlarge to -100 mmHg if activated in TSM

Limits window for arterial entry pressure PA

The arterial entry pressure PA (pressure between patient and blood pump) is monitored by an automatically set limits window. This window is only active in the therapy phase and during final circulation.

A max. lower arterial limit is set in the service program (max. -400 mmHg). The automatically set lower limit cannot fall below this value.

The size of the arterial limits window is defined through the respective distance (delta) between the actual value and the lower and upper limits.

The total of the two distances to the actual value gives the width of the arterial limits window, i.e. in the above example 70 + 70 = 140 (mmHg).

When the actual PA is changed slowly, the limits window is continuously adapted to the actual value, but only within the absolute limits set in the service program.



Danger of injuring patient’s access by excessive negative pressure!

➤ **Ensure that max. PA is adjusted in accordance with the physician’s order.**

Limits window for TMP control

The TMP of the dialyzer is controlled by an automatically set limits window.

The size of the limits window is entered as a percentage of the actual value (see Fig. 5-17). The limits window is therefore independent of the dialyzer in use.

When the limits window is switched off, the control of the dialyzer-dependant max TMP is still active.

Activating the Bypass icon, or changing the blood flow, causes the limits window to be re-centered.

The lower TMP-limit range can be enlarged for the use of highflux dialyzers (see Fig. 5-17). This function has to be enabled in TSM.

Extended TMP-limit range

➤ Touch icon

The lower TMP-limit will be set to -100 mmHg. Through this the backfiltration warning when reaching -10 mmHg is not applicable.

WARNING

Danger of patient blood contamination by microbes in the dialysis fluid!

➤ Ensure that the dialysis fluid is clean.

WARNING

Risk of blood volume increase due to leakage in the hydraulic system (water cycle). Risk of backfiltration.

➤ Check patient weight.
➤ In case of technical defect, call technical service.

i

Backfiltration may occur when "Extended TMP-limit range" is selected. For this reason we recommend the use of a dialysis-fluid filter (Diacap® Ultra).

5.8.6 Setting the heparin parameters

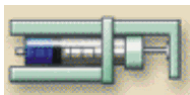

➤ Touch icon in preparation window.
The heparin parameters are displayed.

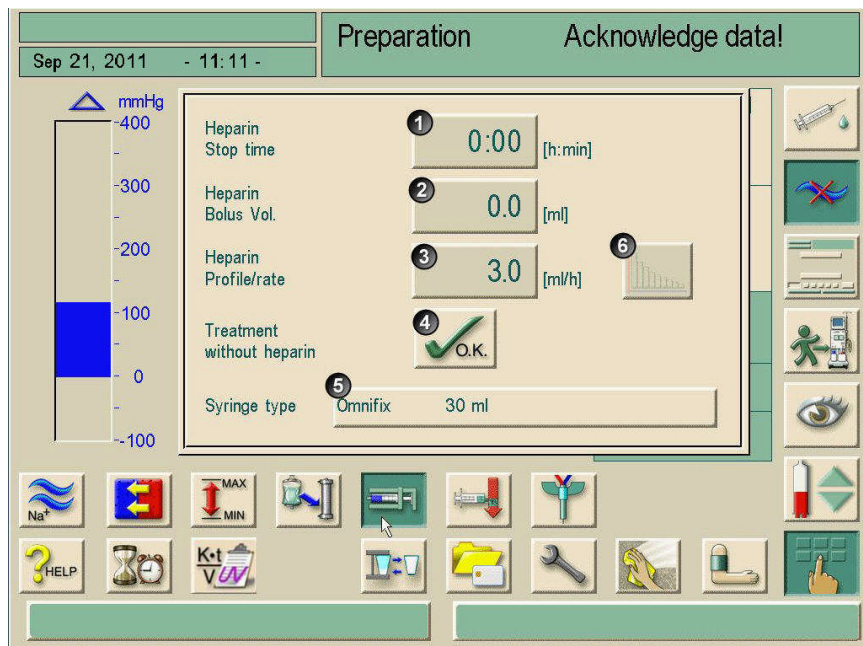

Fig. 5-20 "Heparin parameters" screen

➤ Set heparin parameters according to the below table.

Item	Text	Range	Description
1	Heparin Stop time	0:00 – 10:00 h:min	The heparin pump is switched off by the set time prior to the end of the therapy
2	Heparin Bolus Vol.	0.1 – 10.0 mL	Bolus volume for a bolus administration during dialysis
3	Heparin Profile/rate	0.1 – 10.0 mL/h	Continuous heparin rate over the entire duration of heparin administration
4	Treatment without heparin	deactivated/activated	Switching on/off the heparin monitoring function
5	Syringe type	10/20/30 mL	A list of permissible syringe types is stored in service administration
6	–	–	Setting a profile for heparin administration



Risk to the patient with high risk of internal bleeding (e. g. at recent surgery, gastro-intestinal abscess or similar diseases)!

- Check for indication of internal bleeding during therapy.
- Check the process of heparin application during therapy.



Blood clotting in the extracorporeal system!

- Ensure that the heparin pump is switched on after entering a delivery rate.



If in TSM presetting the Heparin pump is set "off", you'll have to switch it on manually!



Risk to the patient due to wrong anticoagulant dosage caused by a mismatch between the heparin pump selected on the screen and the syringe actually inserted in the heparin pump!

- Always make certain the syringe selected on screen is the same as the type of syringe actually inserted.
- Only use syringes listed in the syringe table.
If necessary, contact technical service.

5.9 Rinsing the dialyzer



Intoxication risk for the patient in case of use of dialyzers packed with germicide. Residual sterilant in the sodium priming bag!

- Verify the absence of sterilant in saline bag.
- Replace saline bag before connecting the patient.

5.9.1 Rinsing the dialyzer using standard A/V tubing

When the dialysate is prepared, an information window appears, with the request to connect the dialyzer.

- Take dialyzer tubings from rinsing bridge and connect to dialyzer. Observe color-coding.
- Turn dialyzer so that the blue connection is facing downward.
- Confirm correct connection of dialyzer by pressing the Enter key ↵ on the monitor. The dialyzer is filled and rinsed.

- Adjust level as follows:
 - Fill chamber in front of the dialyzer entry (PBE) nearly half full.
 - Fill venous drip chamber up to approx. 1 cm from the upper edge.

Once the dialyzer has been filled, the blood pump stops running. An information window appears.

- Ensure that the blood tubing system and the dialyzer are filled and rinsed with physiological saline solution.
- Ensure that the level in the venous chamber is correct.
- Confirm correct settings by pressing Enter key ↵ on the monitor. The dialysis machine is testing the blood tubing system.



This icon is enabled as soon as the dialysis machine has completed all automatic tests and blood side tests.

- Test the dialyzer and lines for a negative sterilant result. The patient can now be connected.



In the case of use of dialyzers packed with germicide, the rinse program should be completed and the dialyzer tested for residual sterilant prior to changing to the therapy phase.

5.9.2 Rinsing the dialyzer using Streamline[®] bloodline

When the dialysate is prepared, an information window appears, with the request to connect the dialyzer.

- Take dialyzer tubings from rinsing bridge and connect to dialyzer. Observe color-coding.
- Confirm correct connection of dialyzer by pressing the Enter key  on the monitor. The dialyzer is filled and rinsed.
- Adjust level as follows:

– Ensure that the venous drip chamber is completely primed.

Once the dialyzer has been filled, the blood pump stops running. An information window appears.

- Ensure that the blood tubing system and the dialyzer are filled and rinsed with physiological saline solution.
- Ensure that the level in the venous chamber is correct.
- Confirm correct settings by pressing Enter key  on the monitor.

The dialysis machine is testing the blood tubing system.



This icon is enabled as soon as the dialysis machine has successfully completed all automatic tests and the blood side tests.

- Test the dialyzer and lines for a negative sterilant result.
- Ensure that the blue connection is facing upwards.

The patient can now be connected.



In the case of use of dialyzers packed with germicide, the rinse program should be completed and the dialyzer tested for residual sterilant prior to changing to the therapy phase. Decalcify the machine after each bicarbonate dialysis if the DF option is used.

5.10 Stand-by mode

The dialysis machine features a stand-by mode for the dialysate side. This mode allows switching off the dialysate side in order to save on permeate and concentrate when the machine is being prepared and will not be used immediately.



Risk of microbial growth in the dialysate during stand-by mode!

Infection risk to the patient!

- Do not use stand-by mode with dialyzers packed with germicide.
- Do not run the dialysis machine in stand-by mode over prolonged periods.
- The recommended duration of stand-by mode depends on the water quality and the environmental conditions (according to the hygiene plan of the dialysis center).

5

5.10.1 Activating the stand-by mode

Depending on the service program setting performed by technical service, there are the following ways in which the stand-by mode can be activated for an adjustable period:

- Automatic start after automatic test sequence
- Automatic start after rinsing program
- Manual start after automatic test sequence
- Manual start after rinsing program

Manual activation of the stand-by mode



- Touch icon.
The dialysis machine is in stand-by mode.
The pumps stop and no dialysate is produced in the machine.

5.10.2 Switching off the stand-by mode

The max. duration of the stand-by mode is preset in the service program by technical service.

Depending on the setting entered by the technical service in the service program, there are the following options for switching off the stand-by mode:

- Manual switch-off
- Automatic switch-off after expired time
- Automatic switch-off during connection of patient

Manual switch-off of stand-by mode (deactivating)



- Touch icon again.
The pumps are started and dialysate is circulated without passing through the dialyzer.
The machine is in bypass.
The machine will remain in bypass until the therapy is initiated.

5.11 Power failure in preparation

During a power failure in preparation the status of this phase will be saved. If the power supply will be restored, only the interrupted step must be repeated by the device, if necessary.

Already entered treatment parameters will remain unchanged.

The saved data will be stored up to 120 minutes. After that time the device has to be newly prepared.

i

This functionality allows for moving of a prepared device to another treatment area.

5.12 Changing the bicarbonate cartridge during preparation

It is possible to exchange a bic cartridge during preparation. (see chapter 10.2).

Table of contents

6	Initiating hemodialysis	6-3
6.1	Checking the patient data.....	6-3
6.2	Connecting the patient and starting hemodialysis.....	6-4
6.2.1	Level regulation in therapy (if present)	6-5
6.3	During hemodialysis	6-7
6.3.1	Monitoring the blood-side pressure limits	6-7
6.3.2	Treatment at minimum UF rate	6-9
6.3.3	Heparin bolus	6-10
6.3.4	Arterial bolus (saline).....	6-10
6.3.5	Graphic representation of treatment parameters (trend)	6-12
6.3.6	Interrupting hemodialysis (bypass)	6-15
6.3.7	Completion of treatment	6-15
6.3.8	Terminating treatment	6-15
6.3.9	Continuing treatment	6-15

6 Initiating hemodialysis

6.1 Checking the patient data

After completion of the preparation work, the icon for connecting the patient is enabled. The signal lamps on the monitor change to yellow.



- Touch icon in preparation screen.

Two brief acoustic signals are sounded. The Enter key ↵ on the monitor is lit up. An overview of the entered patient data appears on the screen.

- Check that both sets of data match. If not, DO NOT USE THE MACHINE.

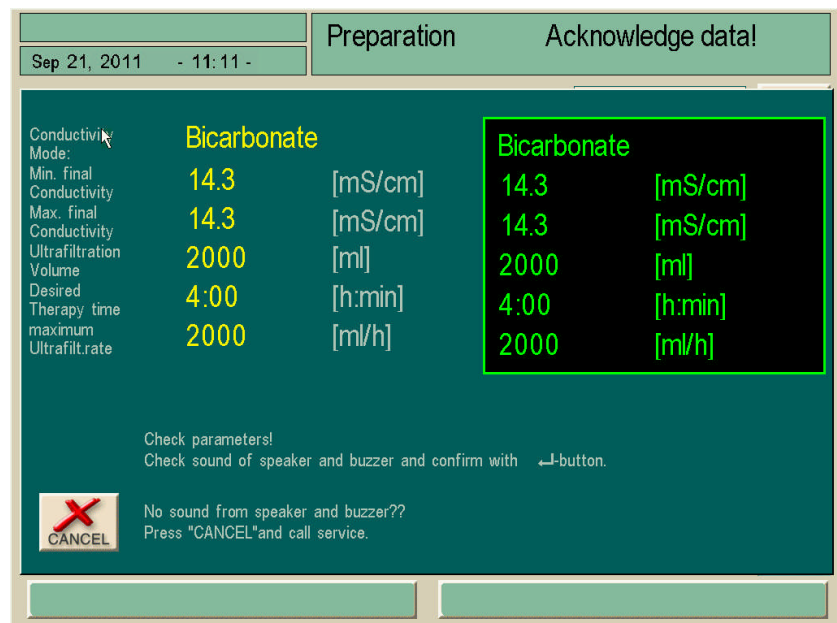

Fig. 6-1 "Patient data" screen



WARNING

Risk to the patient due to inadequate monitoring of treatment parameters!

If only one or no acoustic signal is sounded or Enter key ↵ flashes on the monitor, or if the displayed treatment parameters show discrepancies, the dialysis machine is defective and must not be used!

- Leave screen by pressing CANCEL.
- Call technical service.

- Check that patient data corresponds with what has been prescribed by the doctor and confirm by pressing the Enter key ↵ on the monitor.

The treatment screen appears and the dialysis machine is in the bypass mode.

6.2 Connecting the patient and starting hemodialysis



Risk to patients with central venous catheters, due to excessive patient leakage current!

➤ Connect electrical ground on the dialysis machine, see section 1.5.2.

Legend

- 1 Remaining time, graphical and in numbers
- 2 UF rate
- 3 Actual UF volume
- 4 Set UF volume
- 5 Heparin rate
- 6 Blood flow
- 7 Heparin bolus
- 8 Min UF
- 9 Bypass
- 10 Information bar
- 11 Display of trans-membrane pressure (TMP), with limits
- 12 Display of arterial pressure, with limits
- 13 Display of venous pressure, with limits

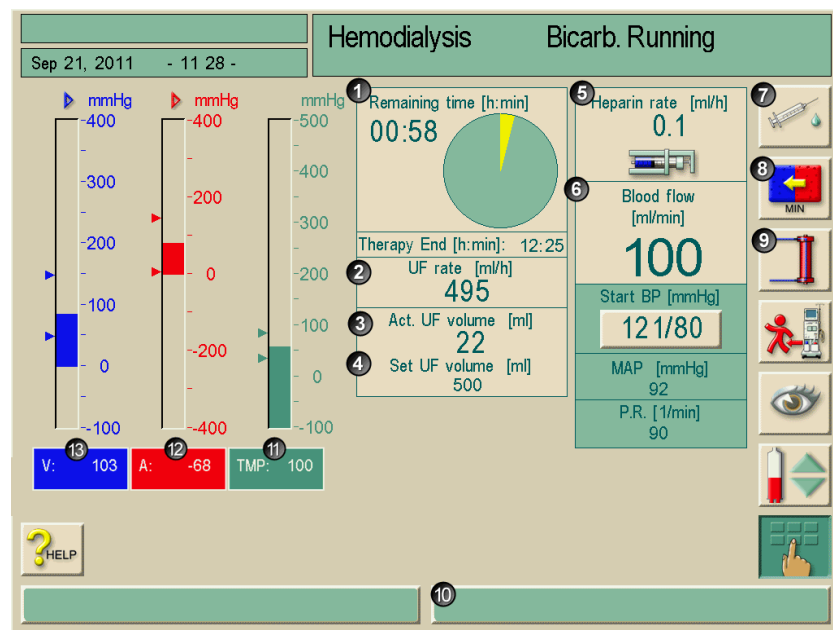

Fig. 6-2 "Hemodialysis" treatment screen

i During the connection phase, the set limit values are not monitored. Therefore, particular care is required during the connection phase.

i The following steps for connecting the patient may be slightly different depending on clinics policy.

- Connect patient arterially.
- Start blood pump by pressing START/STOP button on monitor.
- Set blood flow.
- Fill blood tubing system with blood.

The blood pump stops automatically when blood is detected on the red sensor in the safety air detector (SAD).

- Connect venous blood line to patient.
- Start blood pump and set to prescribed blood flow.
- Touch icon to take machine out of by-pass.

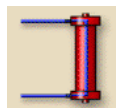

The dialysis machine switches to main flow and bicarbonate running.

The signal lamps on the monitor switch to green.



WARNING

Risk to patient due to hemolysis if the blood flow rate setting is too high for the selected fistula needle (PA pressure too low)!

- **Adjust blood flow rate, taking into consideration the arterial pressure.**



WARNING

Risk to patient due to reduced dialysis effectiveness, since the actual blood flow rate is lower than the displayed flow rate if arterial pressures are highly negative!

- **Correct the blood flow rate setting.**
- **Extend treatment time.**



WARNING

Risk to patient due to reduced dialysis effectiveness since the blood flow rate is too low (for example, wrong size fistula needle)!

- **Ensure that the blood flow rate is optimal.**
- **Ensure that the fistula needle size is correct.**

6.2.1 Level regulation in therapy (if present)

The level regulation system can only be used with regular AV blood tubing not Streamline® blood tubing. The user is able to set blood levels in the blood line chambers in treatment by screen touch.

i

- During treatment, the blood levels can only be set while the blood pump is running in double-needle mode. The active chambers depend on the used blood line system.
- The user is obligated to check for the correct setting of the levels in the chambers.

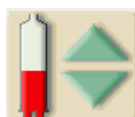

- Touch icon.
The level window opens.

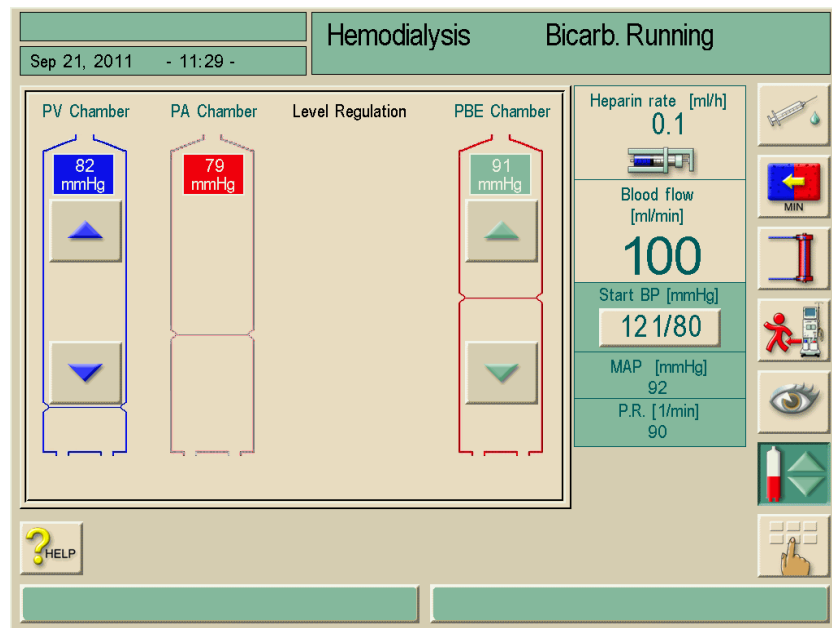

Fig. 6-3 Level regulation screen (if present)

Level increasing

- Touch icon gently with one touch.
- Observe level.
- Touch again for the correct setting if necessary.

Level decreasing

- Touch icon gently with one touch.
- Observe level.
- Touch again for the correct setting if necessary.



- To leave the level regulation function, touch icon again.

i

- In case the blood pump is stopped, the level regulation system is not active. A message is displayed that a previous start of the blood pump is required.
- In case of blood side alarms, level regulation is not possible. Alarms have to be cleared first.



WARNING

Risk to patient due to infection as a result of contamination of the transducer protector on the tubing system!

- Replace the machine-side transducer protector if it was contaminated with blood and blood penetrates the machine.
- Instruct technical service to replace transducer protector.
- Only use the machine again when the filter has been changed.
- Execute disinfection after replacement.



Risk of reduced dialysis effectivity!

- Ensure that no air enters into the dialyzer when decreasing the level in the PBE chamber.

6.3 During hemodialysis



Risk to patient due to blood loss if cannulas get disconnected or dislodged!
Standard monitoring function of the dialysis machine cannot ensure detection if the cannulas get disconnected or dislodged.

- Ensure that the access to the patient always remains fully visible during therapy.
- Ensure that cannulas are adequately fixed.
- Regularly check patient access.
- Venous lower limit should be set to ≥ 20 mmHg in TSM.



Risk of cross contamination if a blood leakage alarm occurs.

- If a blood leakage alarm occurs and tests positive for blood, the machine should be disinfected before using with a different patient to avoid the possibility of cross contamination.



For Streamline® bloodlines (SL-2010M2096) optional PBE sensor cannot be used.

6.3.1 Monitoring the blood-side pressure limits

Venous return flow pressure (PV)

The venous return flow pressure (PV) is monitored by an automatically set limits window. The limits window is set 10 seconds after the last activation of the blood pump and is identified by markings on the bar showing the venous return flow pressure.

The venous pressure alarm limits are set in the service program by technical service.

- The venous lower limit value is automatically adjusted during treatment. This means that the distance between the lower limit and the actual pressure decreases. This compensates for the hematocrit increase generally caused by ultrafiltration. The adjustment is carried out every 5 minutes and adds up to 2.5 mmHg at a time. The minimum distance of 22.5 mmHg is, however, always maintained.
- Check venous lower pressure limit during dialysis. An optimal interval is approximately 35 mmHg between the lower pressure limit and the current value.

By changing the speed of the blood pump for a brief period, it is possible to reposition the limits window. This means that an already modified limit value is put back to the TSM adjusted interval. (See also chapter 5.8.4).

Arterial entry pressure (PA)

The arterial entry pressure (PA, pressure between patient and blood pump) is automatically monitored within set limits. The limits window is set 10 seconds after the last activation of the blood pump.

These limits are active in the therapy phase and during final circulation.

i

When setting the limits window, ensure that the upper limit is as negative as possible.

Blood-side entry pressure at the dialyzer (PBE) with standard AV blood tubing

The PBE must be connected during preparation.

If the PBE pressure transducer protector is used, the blood-side entry pressure at the dialyzer is controlled by its upper venous limit. The PBE monitoring function warns or signals a possible blockage of the dialyzer due to a kinked tube or increased clotting within the dialyzer. The PBE measurement allows the operator to monitor the formation of a secondary membrane layer in the dialyzer. A possible filter clotting might be avoided. The limits can only be set via the Alarm limits screen at the beginning of the therapy.

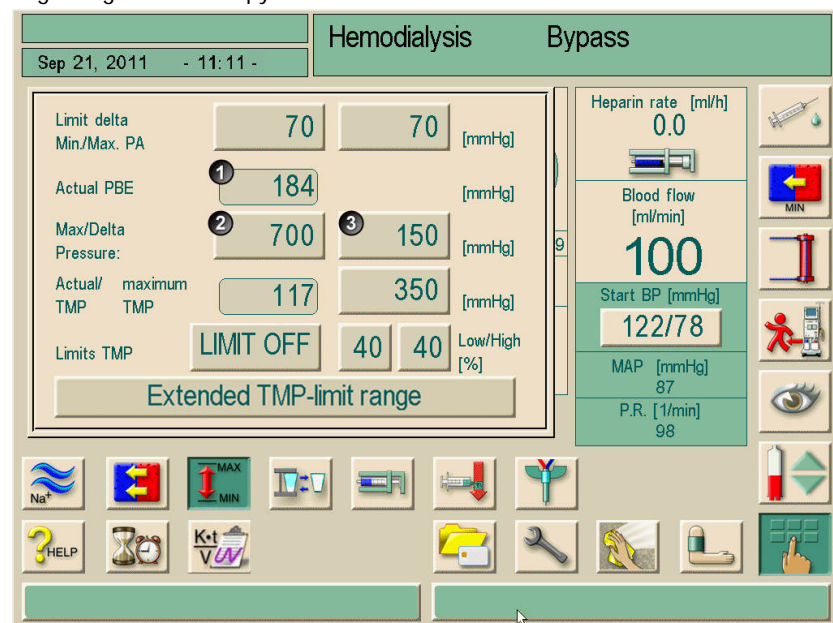

Fig. 6-4 "Alarm limits" screen during therapy

Additionally, to the maximum PBE value (2) the Delta (3) can be adjusted. Delta represents a limiting value which lies above the average actual value of the PBE. The average value of the PBE is determined by the Dialog⁺ within the first five minutes after starting therapy and is stored as a reference value in the SW. Changes of pressure by variations in blood flow are automatically considered, (e.g.: average actual value of PBE at 155 mmHg plus Delta 150 mmHg. The result of this is a PBE limiting value of 305 mmHg). Achieving this limiting value causes a yellow warning text to appear.

Exceeding the limiting value causes a red alert text to appear.



Risk of wrong pressure values!

- Ensure each POD diaphragm is positioned correctly within dome.
- If diaphragm appears misplaced, follow instructions as described in the Streamline® bloodline Instructions for Use.



It is possible to use a blood tubing system without PBE access. The machine realizes the absence of a pressure transducer during preparation. Monitoring PBE during therapy is omitted.

6.3.2 Treatment at minimum UF rate

Treatment at minimum UF rate can be activated to achieve, for instance, an immediate lowering of the set UF rate in case of falling blood pressure and unstable circulation.



The therapy time still continues during treatment at the minimum UF rate. Where necessary, adjust UF volume after a temporary treatment at minimum UF rate.



Activate minimum UF rate

- Touch icon.
The treatment continues with the set minimum UF rate.
The dialysis machine will sound an acoustic signal every 10 minutes.



Deactivate minimum UF rate

- Touch icon again.
The treatment continues with or without UF compensation, depending on the setting.

UF compensation

UF compensation can be activated or deactivated in TSM.

UF compensation - YES

After temporary treatment with minimum UF rate, the preselected UF volume will be automatically achieved by increasing the UF rate in the set UF time.

UF compensation - NO

After temporary treatment at minimum UF rate, the preselected UF quantity will not be automatically achieved in the preset UF time.

6.3.3 Heparin bolus

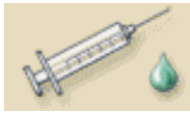

- Touch icon.
A safety message will be displayed.
- Confirm heparin bolus by pressing Enter key ↵ on monitor.
The heparin bolus preset in the heparin parameters is activated.



Risk of blood loss due to blood clotting in case of insufficient anticoagulation!
 ➤ In case of a heparin syringe pump failure, complete heparin bolus manually.

6

i

- The heparin bolus can be repeated.
- Technical service can program the dialysis machine in the service program in such a way that a heparin bolus is automatically administered whenever blood is detected at the red detector on the venous tube clamp. For this purpose, the extracorporeal circulation should be heparinized.

6.3.4 Arterial bolus (saline)

Using the function “Arterial bolus” a defined volume of sodium chloride is infused from a NaCl bag.

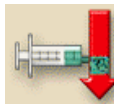

- Touch icon.
The set-up window for the arterial saline bolus is displayed.
- Enter bolus volume.

Legend

- 1 Start bolus
- 2 Bolus volume
- 3 Infusion volume
- 4 Arterial infused volume
- 5 Total of infusion volume

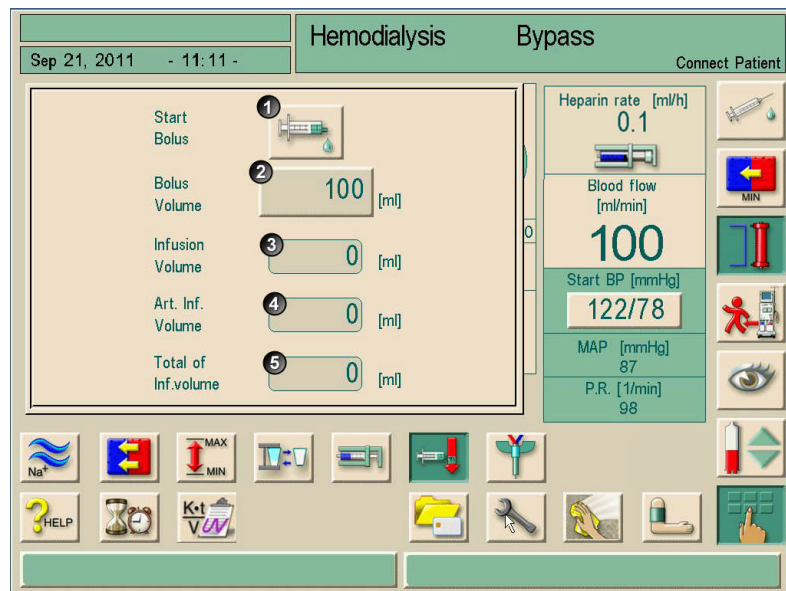

Fig. 6-5 Set-up window for arterial bolus

- Enter bolus volume.

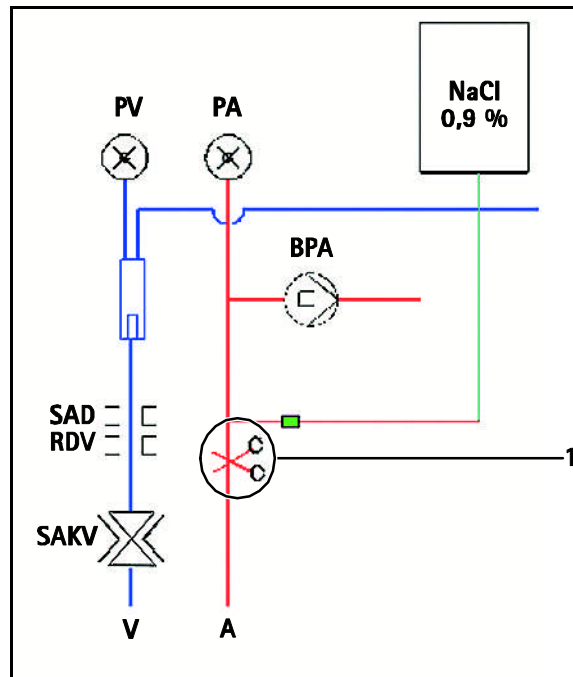

Fig. 6-6 Clamping off the arterial patient inlet



- Touch icon.
 - The blood pump stops automatically and a safety message appears on the screen.
- Connect bag with physiological saline solution to arterial infusion connector.
- Clamp off arterial patient inlet 1 if necessary.
- Confirm arterial bolus by pressing the Enter key ↵ on monitor.
 - The arterial bolus is infused. The values can be monitored in the settings window.
- Once the set quantity has been infused or the arterial bolus has been terminated by an alarm, a window appears to confirm **Bolus terminated**.
- Remove clamp on patient inlet, clamp off infusion line and confirm by pressing the Enter key ↵ on the monitor.
 - The window for the arterial bolus is closed and replaced by the therapy screen.



Risk of hypotensive incident if bolus fails.

- In case of a blood pump failure during an arterial saline bolus or reinfusion, complete bolus manually.
- In case of a prematurely closed venous clamp, complete arterial bolus via hydrostatic infusion.



If the arterial bolus of saline was interrupted by an alarm, the remaining bolus quantity will be infused upon reactivation of the arterial bolus.

6.3.5 Graphic representation of treatment parameters (trend)



➤ Touch icon.

A screen with the graphical representation icon appears.

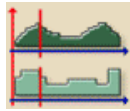

➤ Touch icon.

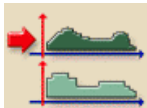

➤ Touch icon.

The following screen is displayed.

6

Legend

- 1 Trend group
- 2 Activate pre-adjustment from TSM
- 3 Edit a trend group
- 4 Save and leave window
- 5 Leave window without saving

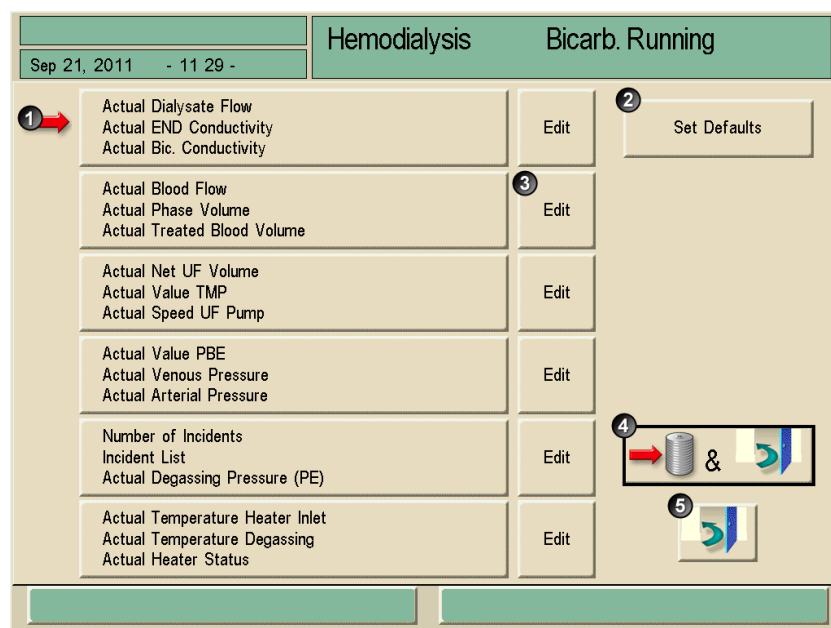

Fig. 6-7 Trend groups

A standard of six groups with three parameters each is preset in the TSM.



Instructions to edit individual trend groups are described in chapter 11.10.

- Touch field of selected trend group.
The following screen is displayed.

Legend

- 1 Graphic representation of a treatment parameter
- 2 Move reference time period forwards
- 3 Move reference time period backwards
- 4 Set time for reference period
- 5 History of trend data

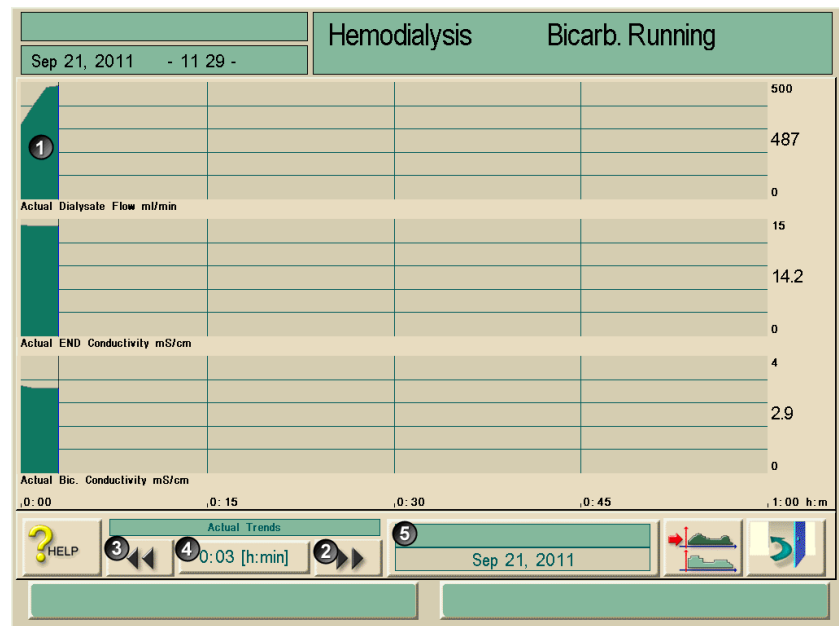

Fig. 6-8 Graphic representation of treatment parameters

Treatment parameters at a defined point in time

There are two ways by which the treatment parameters can be observed at a defined point in time:

1st option:

- Directly enter the time (4) in the Time window.

2nd option:

- Move the time reference line by using the icons << (2) or >> (3).

Call history of trend data

In addition to the current therapy the last 20 therapies carried out with the machine can be displayed.

- Touch field 5

The following screen is displayed.

Legend

- 1 Current therapy
- 2 All therapies, max. 20

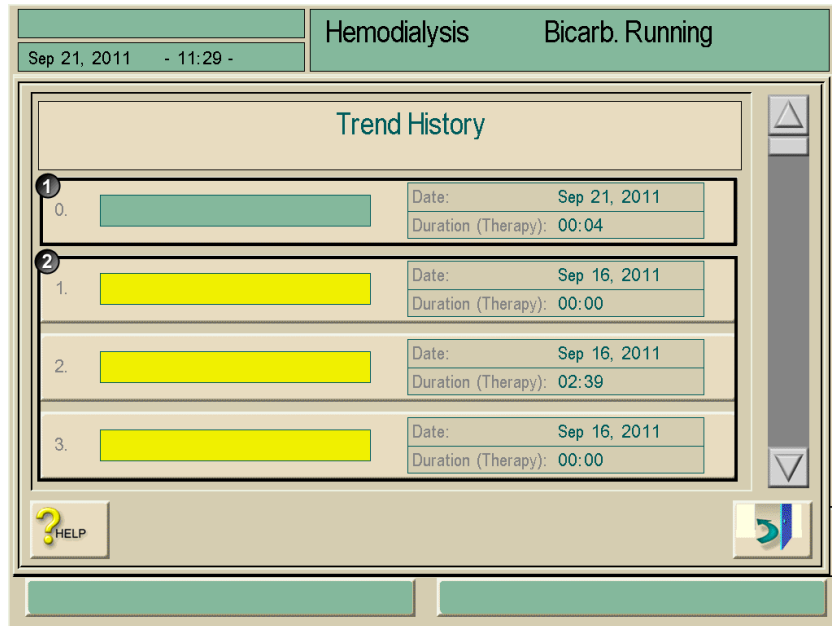

Fig. 6-9 "Trend-History" screen

➤ To open the graphic representation, touch the respective field.
 The background of the name field for the actual therapy is green and the background of the stored therapies is yellow.

i Patient names only appear if they are manually entered before therapy or if a therapy chip card is used.

! Observe local data protection opening trend data which are marked with patient names.

6.3.6 Interrupting hemodialysis (bypass)

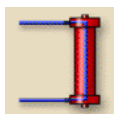

- Touch icon.
The dialysis machine switches to the bypass mode. The hemodialysis is interrupted. The signal lamps on the monitor switch to yellow. The icon changes its display.

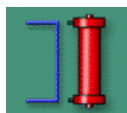

- Touch icon again.
The bypass mode is terminated, the treatment is continued.



Depending on the settings in the service program, the change into the bypass mode must also be confirmed by pressing the Enter key ↵ on the monitor.

6.3.7 Completion of treatment

On completion of the treatment, an acoustic signal can be heard and the message "Treatment time completed" is displayed, the signal lamps on the monitor switch to yellow.

- The UF rate is set to 50 mL/h.
- The blood pump is still running.
- The time beyond the treatment time is shown instead of the remaining time with a minus symbol in front. The graphics will be displayed in blue.

6.3.8 Terminating treatment



- Touch icon.
The message "Terminating treatment" is displayed.
- Confirm termination of treatment by pressing the Enter key ↵ on the monitor.

6.3.9 Continuing treatment



- Touch icon.
After entering new treatment parameters, hemodialysis can be continued.



- Risk of blood pressure drop or cramps exists with continuing ultrafiltration!**
- Ensure that Ultrafiltration will be stopped in appropriate time.

Table of contents

7	Ending hemodialysis therapy.....	7-3
7.1	Reinfusion	7-3
7.2	Emptying the cartridge after dialyzer drain.....	7-5
7.3	Emptying the dialyzer	7-5
7.3.1	Removing dialyzer and blood tubing system	7-5
7.4	Overview of the therapy carried out Touch icon.....	7-6

7 Ending hemodialysis therapy

7.1 Reinfusion



During the reinfusion phase, the limits windows are set to their maximum values. The reinfusion phase therefore demands particular care.

After confirming the End of Therapy, the following screen appears:

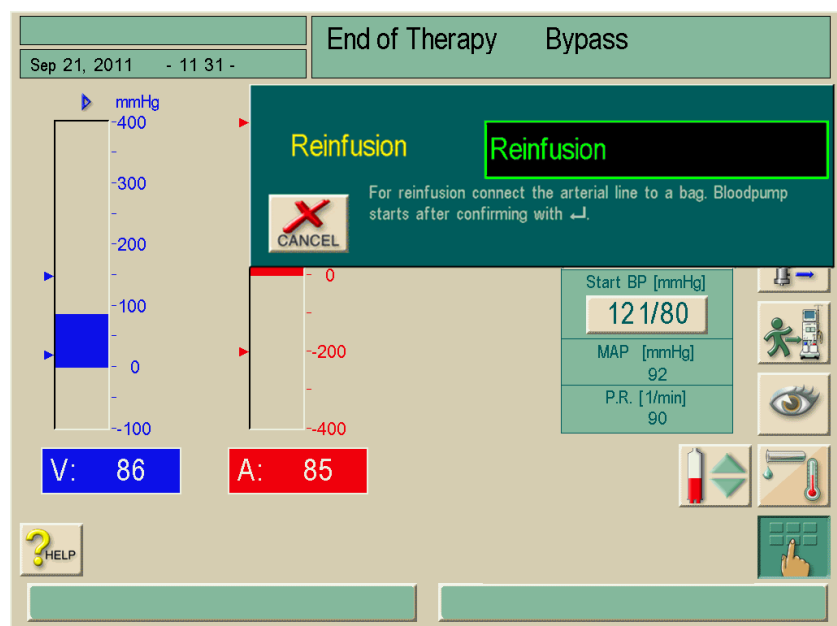

Fig. 7-1 "Confirm reinfusion" screen



The following steps for reinfusion may be slightly different depending on clinics policy.



Danger of air embolism in case of reinfusion with air!

➤ **Only carry out reinfusion with fluids.**

- Remove arterial connection from patient.
- Connect arterial line to infusion Y on saline line containing physiological saline solution.
- Confirm arterial disconnection by pressing the Enter key ↵ on the monitor.

The blood pump starts the reinfusion. The reinfusion screen appears.

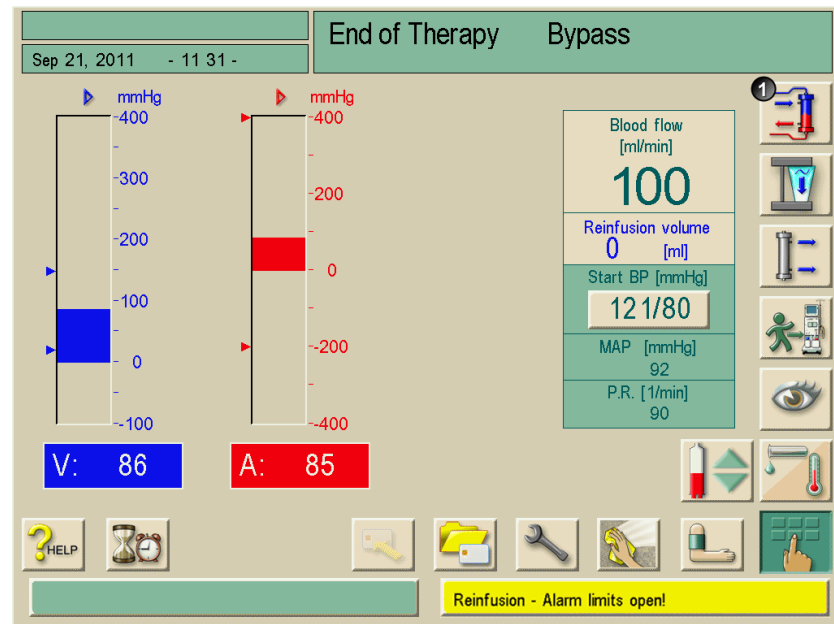

Fig. 7-2 "Reinfusion" screen

The dialysis machine monitors the reinfusion volume and reinfuses until the red detector (RDV) detects the physiological saline solution. The blood pump stops.

- To continue reinfusion, start blood pump by pressing the START/STOP button on the monitor.

The blood pump stops automatically after 400 mL have been reinfused or when a reinfusion time of 5 minutes has elapsed.

The query "Continue reinfusion?" appears on the screen.

- To continue the reinfusion process, confirm by pressing the Enter key \leftarrow on the monitor.

The dialysis machine will carry out reinfusion of another 400 mL, or reinfusion for 5 minutes.

- Disconnect venous patient connection.

i The screen "Confirm reinfusion" (Fig. 7-1) appears only if configured accordingly in the service program. Otherwise, reinfusion must be called up by pressing icon 1 (Fig. 7-2).

i The level regulation system is also active during End of Therapy.

7.2 Emptying the cartridge after dialyzer drain

The cartridge can be emptied before or after emptying the dialyzer.

Emptying the cartridge before the dialyzer is emptied



- Leave both couplings on the dialyzer.
 - Touch icon and confirm by pressing the Enter key ↵ on the monitor.
- The cartridge is emptied automatically.

Emptying cartridge after the dialyzer is emptied



- Connect both couplings to the rinsing bridge.
 - Touch icon and confirm by pressing the Enter key ↵ on the monitor.
- The cartridge is emptied automatically.



Once "Empty dialyzer" has been confirmed, the blood pump cannot be started anymore!

7.3 Emptying the dialyzer

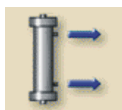

- Touch icon.
An information window describing the next steps appears.
- Follow the instruction given on screen and confirm by pressing the Enter key ↵ on monitor.
The dialyzer is emptied.
- Once the dialyzer has been emptied, connect the second dialyzer coupling to the rinse bridge.



The functions "Empty dialyzer" and "Empty cartridge" can be started simultaneously, although they are carried out successively.

The cartridge is emptied as long as both couplings are connected to the dialyzer or the rinsing bridge.

If the blue coupling is connected to the rinsing bridge, the dialyzer is emptied.

7.3.1 Removing dialyzer and blood tubing system

- Carefully remove the dialyzer and blood tubing system from machine.
Remove the blood tubing system as follows:
- Open the blood pump door and remove the tubing segment from the left side of the pump roller. Carefully rotate the pump clockwise while gently pulling the tubing away from the blood pump roller until the tubing is free from roller.
- Open Safety Air Detector door and carefully remove venous line from the safety pinch clamp.
- Disconnect the arterial and venous pressure sensor lines.
- Remove the heparin syringe rotating the syringe holder counterclockwise. Carefully pull syringe out straight to remove.



Pulling the tubing too hard may result in damage to the blood pump roller.



Remove tubing from tubing guide carefully.

7.4 Overview of the therapy carried out Touch icon



➤ Touch icon.

An overview with the actual values appears for the following values:

- Treated blood volume
- UF volume of hemodialysis
- UF volume of sequential phases
- Heparin volume
- Profile, if set

More parameters can be displayed by actuating the respective icons.

Table of contents

8	Disinfection	8-3
8.1	Procedure and disinfectants.....	8-3
8.2	Preparing for disinfection	8-5
8.2.1	Positioning the disinfectant container	8-5
8.2.2	Selecting the disinfection program	8-5
8.3	Automatic switch-off and restarting.....	8-7
8.3.1	Automatic switch-off after disinfection	8-7
8.3.2	Automatic switch-off and restarting	8-7
8.4	Chemical disinfection.....	8-8
8.5	Short chemical disinfection	8-9
8.6	Thermal disinfection	8-10
8.7	Disinfection of incoming water from water supply.....	8-11
8.7.1	Chemical disinfection with disinfecting solution from central water supply	8-12
8.7.2	Automatic chemical disinfection with disinfectant from central water supply	8-13
8.7.3	Thermal disinfection with hot permeate from central water supply	8-15
8.7.4	Rinsing the permeate inlet.....	8-16
8.8	Checking for disinfectant residues.....	8-17
8.9	Decalcification.....	8-18
8.9.1	Automatic descaling	8-18
8.10	Terminating disinfection.....	8-20

8 Disinfection

8.1 Procedure and disinfectants

Machine disinfection system

The Dialog⁺ disinfection program is intended to remove most of the microorganisms from inside the machine that accumulate over time.

The frequency of machine disinfection should be based on unit protocol while considering the allowable level of bacteria, endotoxin limits, and applicable regulatory requirements. At minimum, B. Braun Medical Inc. recommends that the Dialog⁺ machine be disinfected once per day to disinfect and clean the fluid pathway.

It is also necessary to disinfect the machine after a long out-of-operation time. A reminder appears on the screen after a defined period of time, which can be set in the TSM. Disinfection is performed automatically by the machine with a rinsing and disinfection program. To run the program successfully, connect the machine to the water source, the drain and the disinfectant canister. Also, the dialysate couplings must be connected to the rinse bridge and the concentrate rods have to be tightly inserted into the rinsing chambers. Disinfection can be performed with chemicals or with heat. This includes disinfecting and cleaning the pathway.





Disinfection history

The machine stores 150 disinfections. In this disinfection history, all disinfection dates, procedures breakups and failures are stored and can be checked by the user. When the number of 150 is reached, the oldest disinfection is deleted while a new one is stored.

For cleaning the housing and monitor see section 12.1.

In the disinfection mode, the following programs are available:

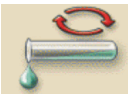
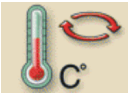
Icon	Disinfection program	Duration of disinfection	Notes
	Chemical disinfection	approx. 35–55 minutes (depending on disinfectant)	
	Short chemical disinfection Also: decalcification with citric acid 50%	approx. 15-45 minutes (depending on disinfectant)	Reduced disinfection effectiveness! Also for decalcification with citric acid 50%, particularly following a bicarbonate dialysis.
	Thermal disinfection 83 – 85 °C/181 – 185 °F	approx. 40 minutes	Use only in exceptional cases. Depending on water quality, carry out chemical disinfection at regular intervals. After a bicarbonate dialysis, first decalcify with citric acid 50%.

Icon	Disinfection program	Duration of disinfection	Notes
	Chemical disinfection with disinfection solution from central water supply manually or automatically	adjustable	Depends on the installed water treatment system With the automatic method the disinfection solution does not contact the optional DF filter.
	Thermal disinfection with hot permeate from central water supply	approx. 30 minutes	Depends on the installed water treatment system
	Rinse permeate inlet	2 minutes up to 10:00 hours adjustable	—

These procedures can be activated or deactivated to allow disinfection tailored to the individual situation.

Beyond that, the following options can be activated or deactivated in the TSM:

- Disinfection necessary after every dialysis
- Termination of disinfection procedure possible/disabled
- Automatic disinfection

Recommended disinfectants

- Thermal with citric acid 50%
- Active chlorine-based disinfectants 5.25-6.15% sodium hypochloride



Potential machine damage by disinfectant solutions and concentrations not recommended for use!

➤ Ensure that the concentration of available chlorine in disinfectant corresponds to a solution of 5.25–6.15% sodium hypochloride (e.g. Ultra CLOROX®). Failure to comply may void the machine warranty.



For disinfection program “chemical disinfection” citric acid 50% with heat can be chosen as disinfectant. The disinfecting effects during this program rely on the temperature of 83 °C/181 °F.



Settings in the service program, such as intake volume, disinfection time, temperature or rinsing time, can only be configured by technical service!



Risk of cross contamination if a blood leakage alarm occurs.

➤ If a blood leakage alarm occurs and tests positive for blood, the machine should be disinfected before using with a different patient to avoid the possibility of cross contamination.

8.2 Preparing for disinfection



Danger of air embolism because safety air detector (SAD) not active!

- Do not connect patient to the machine during disinfection!
- **DO NOT USE** the blood pump for infusion outside the "Therapy" phase (e.g. saline solution)!



Scalding or chemical burns are hazardous for users if disinfectants escape from connection points!

- **During disinfection:**
Do not remove dialyzer couplings.
Do not pull out concentrate suction rods.



Chemical burn hazard for users if concentrated disinfectants are sprayed or spilled!

- Take appropriate measures, e.g. wear protective clothing, goggles and face mask.
- Rinse off splashes on skin and clothing with clear water.



Unsuitable disinfectants

The following substances may not be used for disinfecting the dialysis fluid filter:

- Chlorine-containing fluids and organic solvents, e.g. chloroform, acetone, ethyl alcohol
- Alkaline solutions, e.g. sodium hypochlorite (bleach)
- The manufacturer will not accept any liability if unsuitable disinfectants are used.

- Ensure that sufficient suitable disinfectant is connected.
 - If necessary, change disinfectant container.
 - If necessary rinse any residual solution from disinfection line.

Take into consideration that a disinfection cycle may be started automatically at a later time.

8.2.1 Positioning the disinfectant container

- Insert disinfectant container into fixing at the rear of dialysis machine.
- Connect disinfectant line to the disinfectant connection on the rinsing bridge.
- Ensure that the disinfectant container is not positioned higher than the rinsing bridge.

8.2.2 Selecting the disinfection program

You can select the disinfection program before or after the dialysis.

Selecting the disinfection program before the dialysis

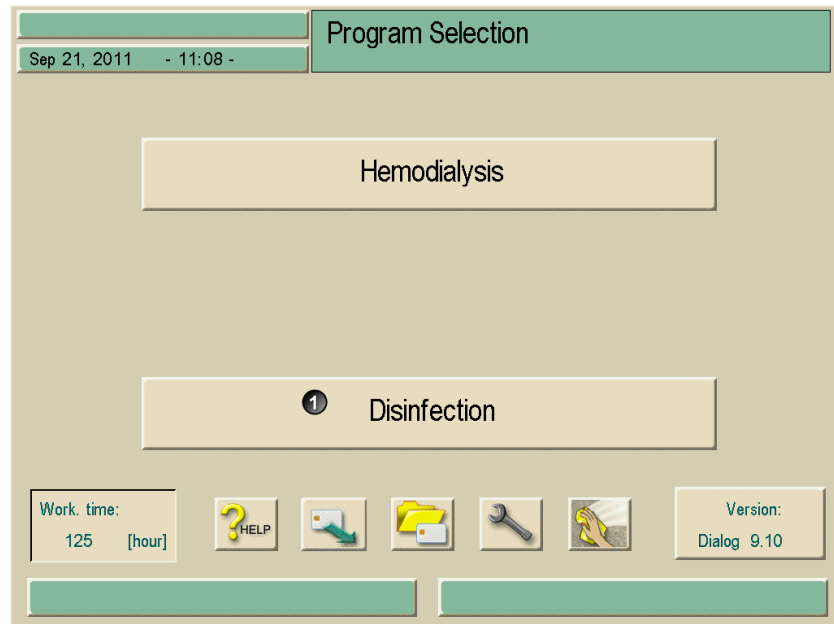

Fig. 8-1 Program selection

➤ Touch field 1. Select OK when window comes up.
The screen listing the different disinfection programs appears.

Legend

- 1 Select disinfectant
- 2 Thermal disinfection
- 3 Chemical disinfection
- 4 Short chemical disinfection
- 5 Rinse permeate inlet
- 6 Chemical disinfection with disinfection solution from central water supply
- 7 Thermal disinfection with hot permeate

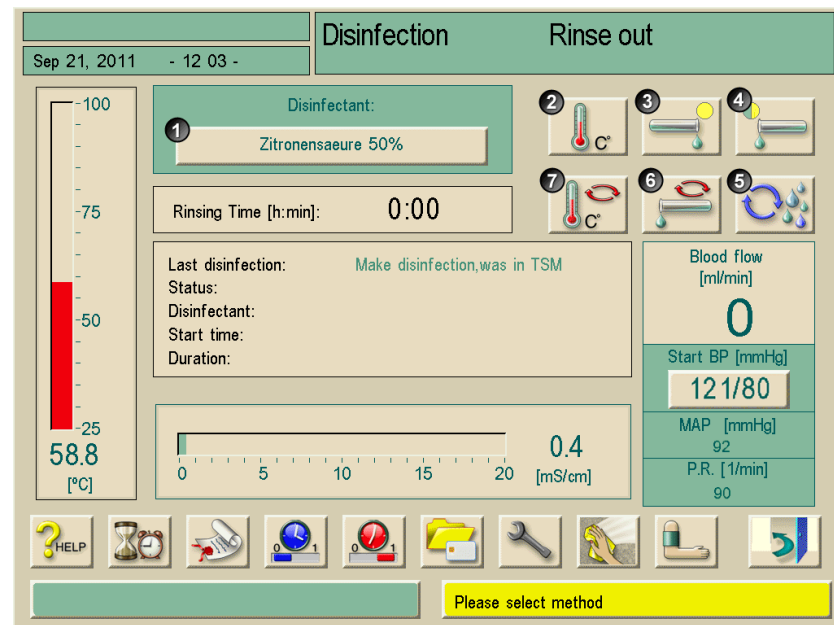

Fig. 8-2 Selection of Disinfection program

➤ Select disinfectant in field 1.
➤ Select Disinfection program through icons 2 to 7.



Selecting the disinfection program after dialysis

- Touch icon.

The screen with the different disinfection programs is displayed, see Fig. 8-2.

- Select disinfectant in field 1. Select OK when window comes up and confirm by pressing the Enter↵ key
- Select disinfection program through icons 2 to 7.

8.3 Automatic switch-off and restarting

The following disinfection settings are available:

- Automatic switch-off after disinfection
- Automatic switch-off and restarting
- Weekly Disinfection program, see section 11.2

8.3.1 Automatic switch-off after disinfection

If the automatic switch-off function is activated, the machine will switch-off automatically after each manually started disinfection. A time-out can be set by the user. Please see chapter 11.1.

8.3.2 Automatic switch-off and restarting



The use of water detectors is recommended for detecting potential leakages during unsupervised operation.

This function allows switching off the dialysis machine automatically after disinfection. The dialysis machine is switched on automatically at the specified time and prepares the next dialysis.



- Touch icon.

A screen showing the settings of the Weekly Disinfection program appears:

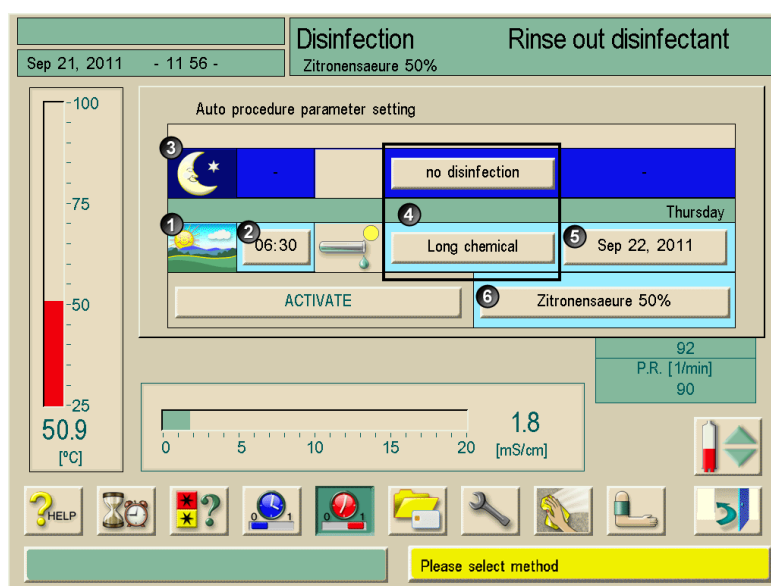

Fig. 8-3 Automatic switch-on

- Set the parameters:
 - Start time with field **2**
 - Disinfection program with field **4**
 - Date with field **5**
 - Disinfectant with field **6**
- Activate settings with field 7.

An information window about the automatic switch-off will be displayed.

In case of a night disinfection (**3**, Fig. 8-3), the dialysis machine switches off automatically on completion of the disinfection cycle.

In case of a daytime disinfection (**1**, Fig. 8-3), the machine switches to "Preparation" after the disinfection cycle, or it remains in rinse-out mode, depending on the settings performed in the service program by technical service.

- Confirm information by pressing the Enter key **↵**.

The dialysis machine switches off after the disinfection cycle. At the set time, the dialysis machine switches on again and carries out the set disinfection.



Leave power switch of dialysis machine switched on.
 Ensure that sufficient disinfectant is connected.
 Disinfection must in each case be reactivated for the following day.

8.4 Chemical disinfection



Damage to dialysis fluid filter system!

- Where dialysis fluid filters are used, only use the disinfectants specified in the **Instructions for Use of the dialysis fluid filter for disinfection.**

The user may choose between a chemical disinfectant, an active hypochlorite base (bleach) or an acidic agent such as citric acid 50% with heat (83 °C/181 °F). When performing bicarbonate dialysis, a citric thermal acid disinfection is recommended in order to prevent calcification of the hydraulic system.

Chemical disinfection takes between 35 and 55 minutes depending on the disinfectant and the water inlet temperature.

Water flows inside the machine fluid path and is mixed with a defined amount of disinfecting agent.

Conductivity sensors measure the actual concentration. After a circulation phase, a rinse phase with pure decalcified water cleans the fluid path from disinfectant residuals.

Example of TSM settings

Disinfectant	Volume [mL]	Reaction time [min]		Rinsing time [min]	Temperature [°C/°F]
		long	short		
Citric Thermal	120	15	5	5	83/181
Decalcification short	Please refer to Service Manual.				
Bleach	90	15	5	25	30/86



- Select disinfectant, e.g. "Citric Thermal".
- Touch icon.

The sequence of the disinfection program is displayed in field 1.

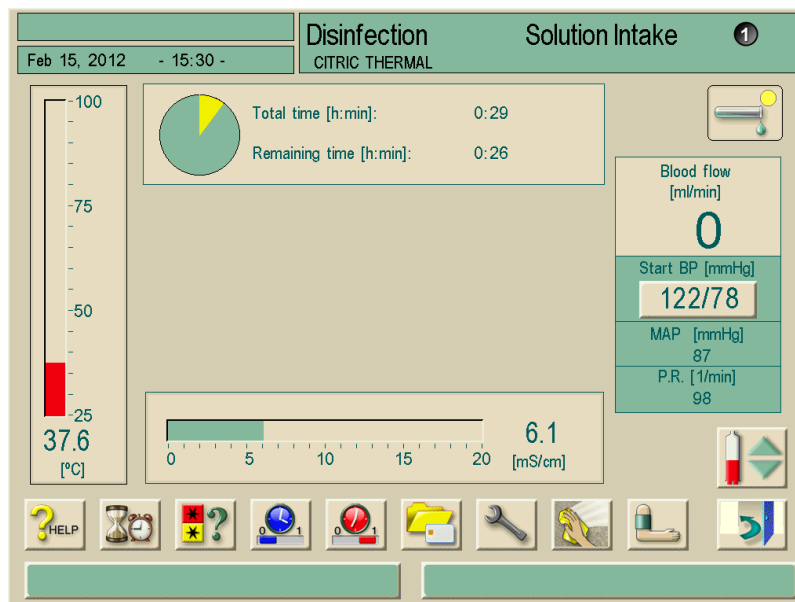

Fig. 8-4 "Chemical Disinfection" screen

Sequence

After activation, the chemical disinfection is carried out automatically as follows:

- Automatic rinse-out
- Aspiration of disinfectant and start of heating cycle
- Disinfection phase: Exposure and circulation
- Rinse-out phase

End disinfection

- Check system is free of disinfectant, see section 8.8.



If citric acid 50% was used as disinfectant, a check for disinfectant residues is not necessary.

8.5 Short chemical disinfection



Short chemical disinfection is intended only for decalcification and can be carried out only with citric acid!



- Activate icon.
The short chemical disinfection is carried out.
- Check system is free of disinfectant, see section 8.8.

8.6 Thermal disinfection

Water flows inside the machine fluid path and is heated until it reaches a temperature of 85 °C/185 °F, then it circulates and cools down again. The procedure takes approx. 40 minutes.



Use thermal disinfection only in exceptional cases as its germ-reducing effect is not sufficient for regular application.

Thermal disinfection is not suitable after bicarbonate dialysis, as the dialysis machine needs to be decalcified.

After a bicarbonate dialysis, chemical disinfection with citric acid 50% is recommended.

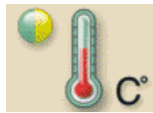

➤ Touch icon.

The thermal disinfection is started.

The progress of disinfection cycle is displayed on screen.

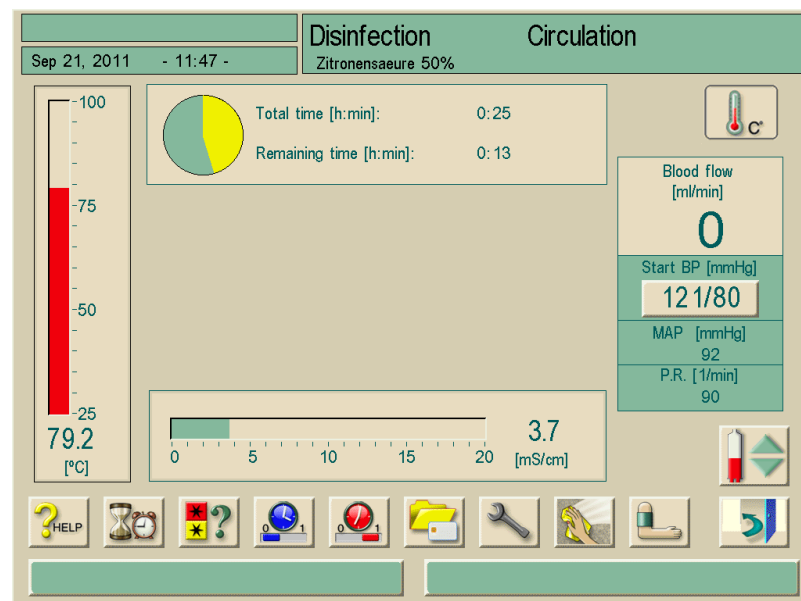

Fig. 8-5 "Thermal Disinfection" screen

After activation, thermal disinfection is carried out as follows:

- Automatic rinse-out
- Heating to at least 85 °C/185 °F
- Disinfection: Exposure and circulation
- Cooling down

8.7 Disinfection of incoming water from water supply

The dialysis machine offers the option of chemically or thermally disinfecting the incoming water supplied through the water treatment system. The water treatment system must be suitable for this procedure.

Recommended disinfectants see table below:

Disinfectant	Machines without DF filter	Machine with DF filter
Heated Water	X	X
Paracetic Acid	X	X
Chlorine Based (bleach)	X	-

The temperature monitoring during this disinfection program refers to the dialysis machine and **not** the supply line.

i

Removal of fluid from the central water supply influences the temperature.

The use of water detectors is recommended for detecting potential leakages during unsupervised operation.

For information about the disinfection of the water treatment system, refer to the operating instructions for water treatment system.



WARNING

Risk of patient injury with disinfectants left in the supply water!

- During central disinfection install a warning sign on the dialysis machine, e.g. "Disinfectant in inlet line!"
- Reuse dialysis machine for dialysis operation only after the water inlet line has been adequately rinsed.
- Only connect inlet tubes to central water supply after they have been cleared of disinfectant.



WARNING

Contamination risk to patients if machine is not adequately disinfected!

- Disinfecting of the water inlet system is no substitute for disinfecting the machine.
- Disinfect the dialysis machine separately after disinfecting the water supply line.



CAUTION

Risk of damage to the machine due to material changes caused by unsuitable disinfectants!

- Only use agents suitable for Dialog⁺ dialysis machine for disinfecting the water inlet line.

8.7.1 Chemical disinfection with disinfecting solution from central water supply

During chemical disinfection of the water inlet, the disinfecting solution is taken from the central water supply and pumped into the dialysis machine.



➤ Touch icon.
The following screen appears:

Legend

- 1 Set flow rate for inlet disinfection
- 2 Set duration for disinfection of the inlet line
- 3 Set flow rate for rinse-out
- 4 Set duration for rinse-out

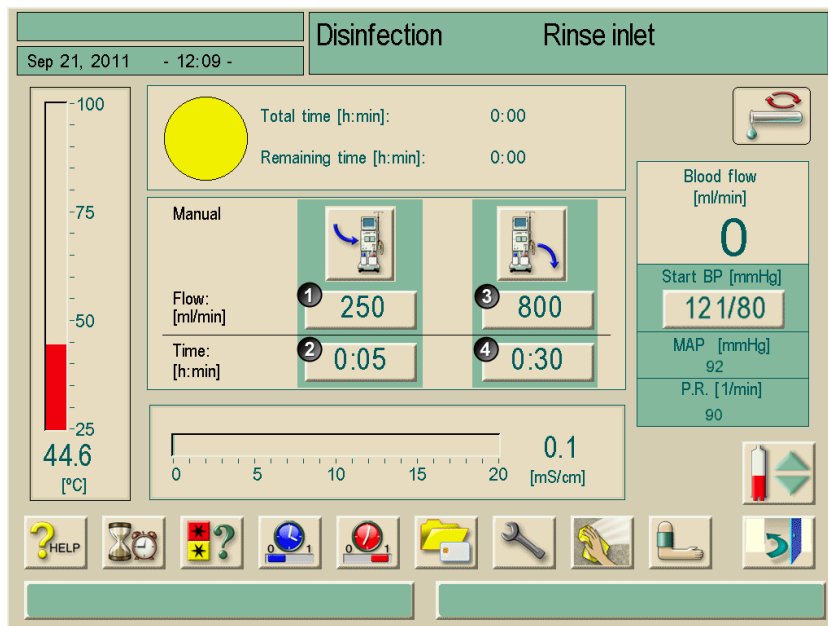

Fig. 8-6 "Disinfection" screen

- Set the parameters:
- Inlet flow in field 1
 - Inlet time in field 2
 - Rinse-out flow in field 3
 - Rinse-out time in field 4

If the central water supply contain disinfectant:



➤ Touch icon.
Inlet supply is started and stopped after the preset time.

Once all disinfectant has been rinsed out of the central water supply:

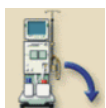

➤ Touch icon.
Rinsing of the dialysis machine supply line is started and stopped after the preset time.
➤ Check supply line and dialysis machine for disinfectants.

8.7.2 Automatic chemical disinfection with disinfectant from central water supply

i

This disinfection method should only be performed by staff who is also trained for RO equipment.

Due to technical defects, disinfectant or water from central water supply could leak inside the dialysis machine. The use of a humidity sensor is recommended.

During the automatic chemical disinfection of the water branch, the disinfectant solution is removed from the central water supply into the dialysis machine. With this method certain valve positions prevent contact of the disinfectant with the DF-filter.



- Select disinfection screen
- Touch icon.

The following screen appears.

Legend

- 1 Day disinfection
- 2 Set time
- 3 Night disinfection
- 4 Select disinfection program
- 5 Set date
- 6 Select disinfectant
- 7 Activate week program

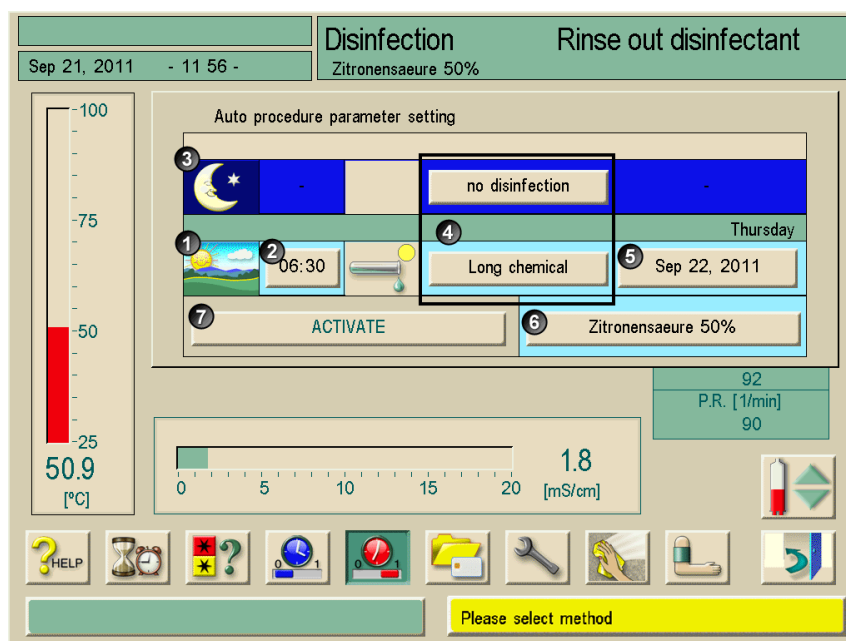

Fig. 8-7 "Disinfection" screen

- Touch button for disinfection method. (Fig. 8-7, 4)
- Choose "Water inlet chemical", confirm with O.K.
- Set switch ON time.(Fig. 8-7, 2)
- Touch button "Activate" (Fig. 8-7, 7)

A warning window for the automatically switching OFF appears. The dialysis machine switches OFF after disinfection. At the preset time the machine will switch ON again and execute the chosen disinfection.



Keep power switch ON.

Ensure that there will be enough disinfectant with the right concentration available in central water supply. Otherwise disinfection effectiveness might be reduced.

The following screen appears when switching ON:

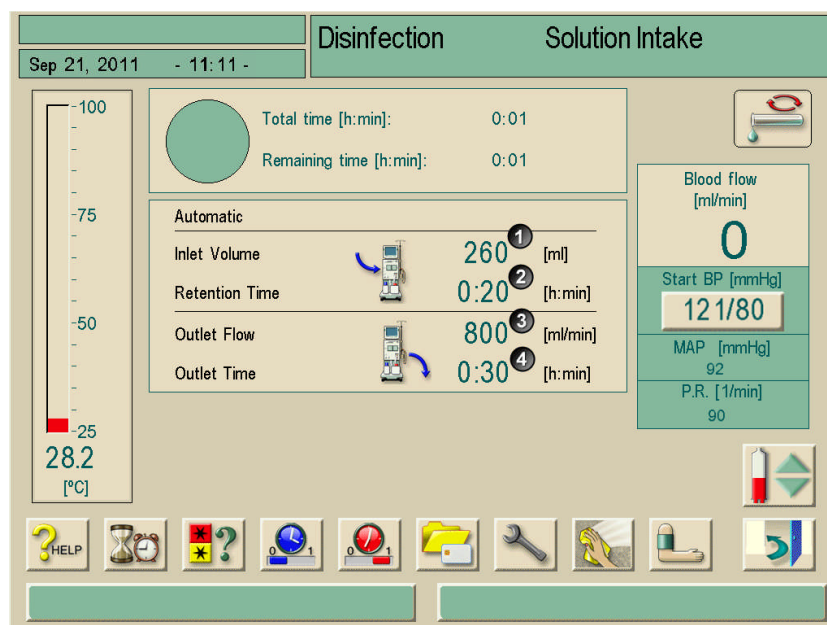

Fig. 8-8 "Disinfection" screen

If the inlet volume (1) is reached, the dialysis machine deactivates itself. After the end of the adjusted residence time (2) the machine reactivates and starts the rinse phase with adjusted parameters (3 and 4).

The service technician can preset the machine in TSM so that it will not reactivate itself. The dwell time ends and the rinse phase starts if the machine is switched ON manually.

If disinfection parameters are put in as night disinfection, the machine switches OFF after rinsing phase.



Risk of poisoning the patient with residual disinfectants in the dialysis machine!

- During central disinfection install a warning sign on the dialysis machine, e.g. "Disinfectant in dialysis machine!"
- Make sure that disinfectant-free water will be available at the beginning of rinse phase.
- Do not use the machine for therapy until sufficient rinsing has been completed.
- Test if the dialysis machine is disinfectant-free.
- Only switch the machine ON if the RO equipment is switched ON, because if the water pressure is low, disinfectant could flow from the inlet into the central water supply.

8.7.3 Thermal disinfection with hot permeate from central water supply

During this disinfection program hot permeate is taken from the central water supply into the dialysis machine. If necessary the permeate is heated up to the temperature which is required for thermal disinfection of the dialysis machine.



➤ Touch icon.

The following screen appears and the program starts.

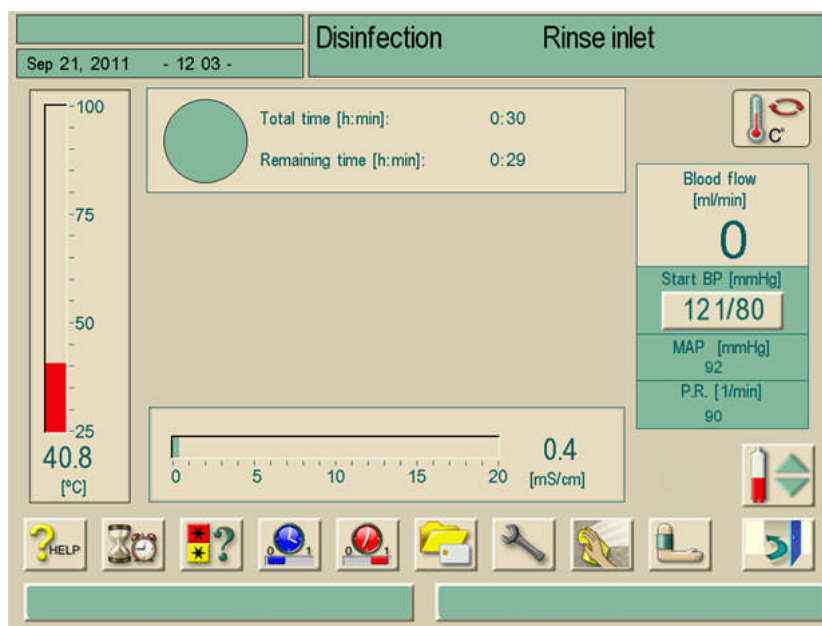

Fig. 8-9 "Central thermal disinfection" screen

8.7.4 Rinsing the permeate inlet

Ensure that the dialysis machine is switched on and connected to the central water supply.



➤ Touch icon.

The following screen appears and the program is started.

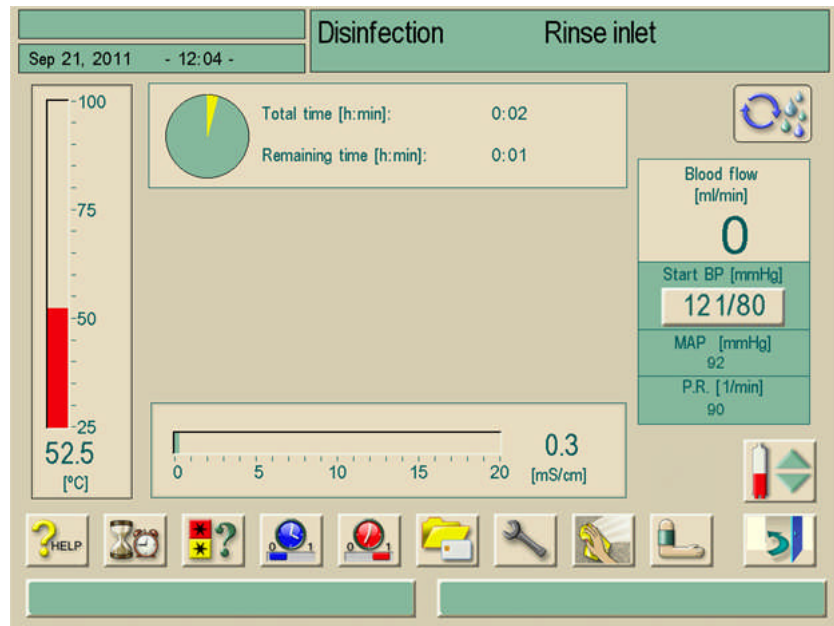

Fig. 8-10 "Rinse permeate inlet" screen

8.8 Checking for disinfectant residues



Risk of patient injury with residual disinfectant left in the machine!

- After using disinfectants, check for any disinfectant residues on the dialyzer couplings and on the discharge outlet!



If citric acid 50 % was used as disinfectant, a check for disinfectant residues is not necessary.

The following information window appears on screen after the set rinsing time:

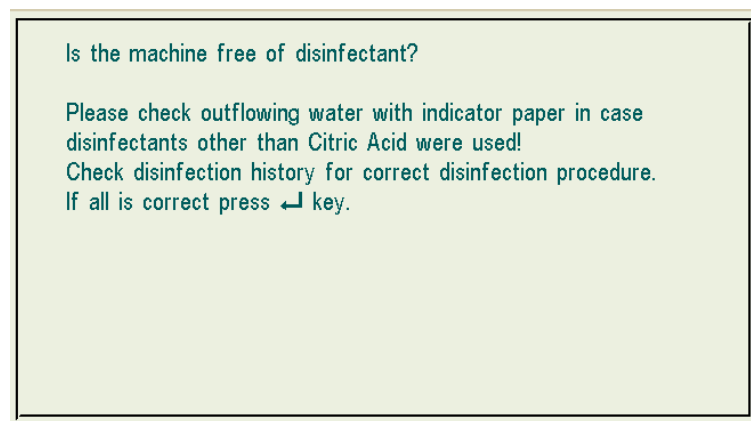

Fig. 8-11 Information window "Disinfectant residue check"

The following indicators can be used to check that the system is free from disinfectant:

Disinfectant	Disinfectant residue check
Citric acid 50%	pH comparison
Bleach	Bleach test strip
Paracetic Acid	Peroxide test stripe

If the dialysis machine still contains some disinfectant:

- Continue rinsing of dialysis machine and repeat indicator test.

If dialysis machine is free from disinfectant:

- Press Enter key ↵ on the monitor.



- Touch icon.

The dialysis machine moves to program selection.

Depending on configuration, the dialysis machine either switches to the preparation screen or remains in the Rinse-out screen at the end of the rinse-out time. However, the window for confirming that the system is free from disinfectant remains active until it is confirmed by pressing the Enter key ↵ on the monitor.

8.9 Decalcification



When using citric acid 50% with thermal disinfection, a separate decalcification of the dialysis machine is not necessary.

When using alkaline disinfectants (such as bleach), a "Decalcification" with citric acid 50% must first be carried out. See table in section 8.4.

8.9.1 Automatic descaling



Effective descaling of the DF filter is influenced by the preset contact time and the temperature used during the cleaning cycle that is set in the TSM. Dialysis therapies using higher concentrations of bicarbonate may require longer contact time and higher temperature.



There may be a risk of uncontrolled UF withdrawal from patient due to a calcified dialysis fluid filter.

- **To prevent this, perform decalcification with citric acid 50% after each treatment.**
- **Alternatively, the automatic descaling function can be performed after each treatment if activated in TSM.**



Risk of blood contamination.

- **Use the same type of acid concentrate as used in the previous treatment.**

The automatic descaling function can be enabled in TSM. Instead of citric acid, acid concentrate used for treatment is drawn in from the machine in high concentration to decalcify the DF Filter between two bicarbonate therapies. It does not replace disinfection.



Automatic descaling is required if the machine is equipped with the option DF filter.

- After the patient is disconnected from the machine, empty the dialyzer as usual.
- Connect the dialyzer couplings to the rinsing bridge.

i

The bicarbonate cartridge may be left in the holder during the process.

The bicarbonate concentrate coupling may be left connected to the concentrate source during the process.

- Ensure connection of acid concentrate coupling to concentrate source.
- The descaling process will start automatically after End of Therapy without any method selection if the user enters into Disinfection.

i

Automatic descaling only starts after a bicarbonate dialysis.

Automatic descaling cannot be started manually.

The following screen appears and the process is started:

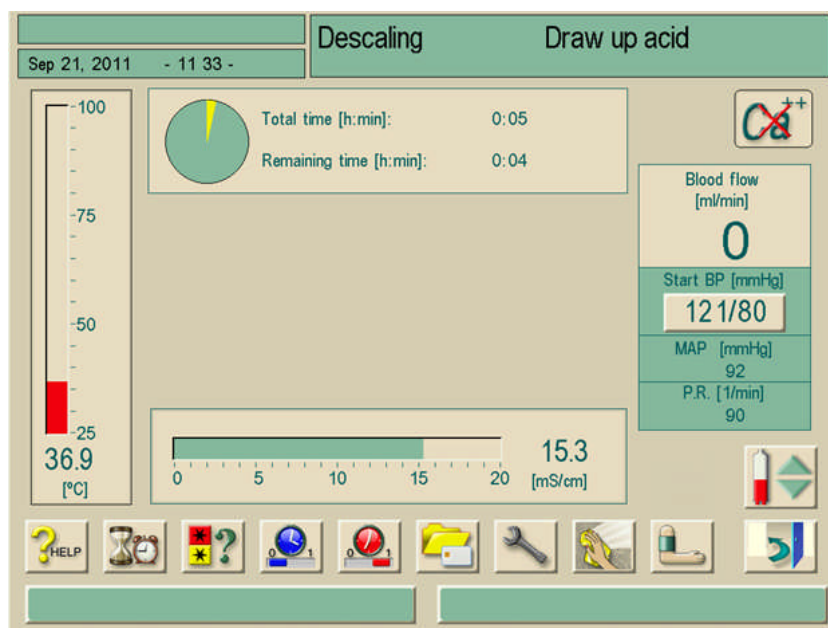

Fig. 8-12 "Descaling" screen – Acid drawing up

After acid is drawn up, the machine enters into acid rinse out.
The following screen appears:

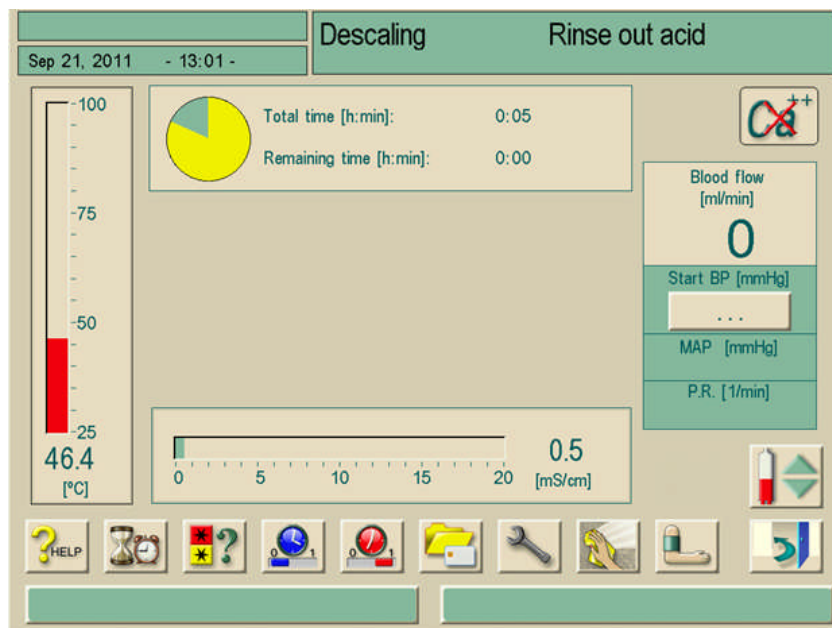

Fig. 8-13 "Descaling" screen – Acid rinse out

As soon as acid rinse out is completed, the machine enters into Preparation and starts the preparation process if the "Automatic Preparation Start after Disinfection" has been enabled in TSM.

If "Automatic Preparation Start after Disinfection" is disabled in TSM, the machine enters into Disinfection and starts disinfection rinsing automatically. In this case, all couplings must be on the rinsing bridges and the cartridge holder must be closed.

Automatic descaling can be interrupted in any phase of the process. The machine will go to Disinfection main screen and the acid rinse out will be carried out. Afterwards, disinfection rinsing will start automatically.

8.10 Terminating disinfection



- Touch icon.
An information window appears.

i

If disinfectant has already been pulled in, the termination of the program is followed by a rinse-out phase (e.g. 5 minutes when using citric acid 50%, or 25 minutes when using an active chlorine disinfectant).

If the setting "Disinfection after every dialysis" has been configured, a **full** disinfection must be carried out prior to the next dialysis.

- To terminate the disinfection, press Enter key ↵ on the monitor.
The "Select disinfection program" screen is displayed, see Fig. 8-2. You can select a different disinfection program.

Table of contents

9	Single-needle procedure	9-3
9.1	Single-needle valve (SN-valve)	9-3
9.1.1	Preparing the therapy.....	9-3
9.1.2	Level regulation in SN-valve mode (if present).....	9-5
9.1.3	Running the therapy	9-7
9.1.4	Ending the therapy	9-8

9 Single-needle procedure

9.1 Single-needle valve (SN-valve)



In the following steps, we describe the single-needle procedure only as far as it differs from double-needle dialysis. For detailed operating information see chapter 5, 6 and 7.



For Streamline® bloodline (SL-2010M2096) single-needle valve cannot be used.

9.1.1 Preparing the therapy

Insert tubing

The following is required:

- AV set for SN-valve (venous chamber 100 mL) or normal AV set for Dialog+ dialysis machine (venous chamber 30 mL)
- For Dialog+ single-pump machine: Option SN-valve with arterial tubing clamp (without arterial tubing clamp, increased recirculation will occur)



WARNING

Low effectiveness due to high recirculation ratio at small phase volumes when single-pump machines without SN-valve option are used!

- **Set phase volume > 12 mL.**

- Insert standard arterial tubing.
- Push arterial tubing through arterial tubing clamp (if present).
- Insert venous tubing.
- Place venous tubing through venous tubing clamp.
- Connect pressure sensors PA, PBE, PV. Check for secure seat.



SN-valve can also be selected during a running therapy.

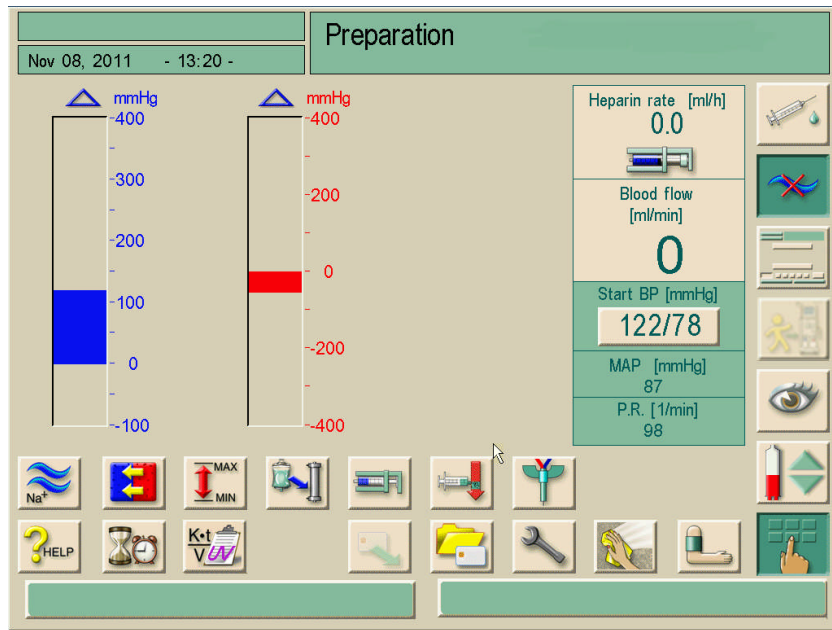

Fig. 9-1 Preparation window

9



Setting the SN-valve mode

➤ Touch icon (1).
The following screen appears:

Legend

- 1 Set SN-valve min. PA
- 2 Set SN-valve parameters
 - SN-valve min. PV
 - SN-valve max. PV
- 3 Activate SN-valve mode
- 4 Connect patient
- 5 Call-up single-needle selection

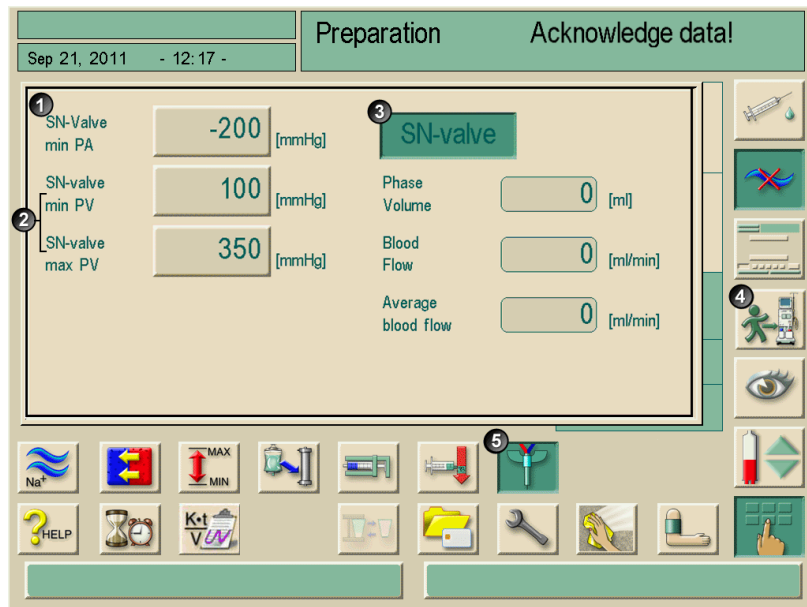

Fig. 9-2 Single needle SN-valve

! It is possible to set a lower max. limit to protect the arterial pressure limit.

- Touch field SN-valve (3).
The field lights up in green.
The preset control pressures **min. PV** and **max. PV** are displayed.

Legend

- 1 Set SN-valve min. PA
- 2 Set SN-valve parameters
 - SN-valve min. PV
 - SN-valve max. PV
- 3 Activate SN-valve mode

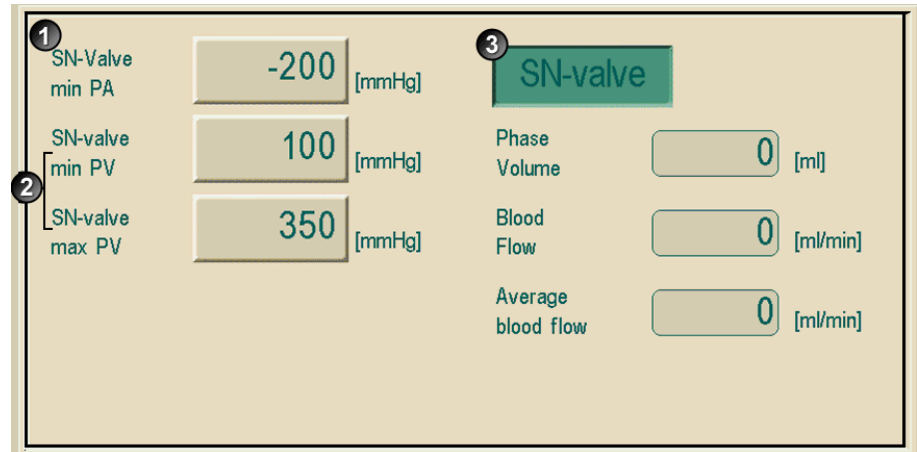

Fig. 9-3 SN-valve parameters

In order to achieve the highest effective blood flow at minimum recirculation, the control pressures must be set for an optimum phase volume.

9.1.2 Level regulation in SN-valve mode (if present)

The level regulation system (if present) allows the user to set blood levels in the blood line chambers in single-needle valve mode by screen touch.



The user is obligated to check for correct setting of the levels in the chambers.

In SN-valve mode, the blood level regulation requires a previous blood pump stop automatically performed by the machine.

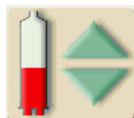

- Touch icon
The level window opens. All chambers are inactive.

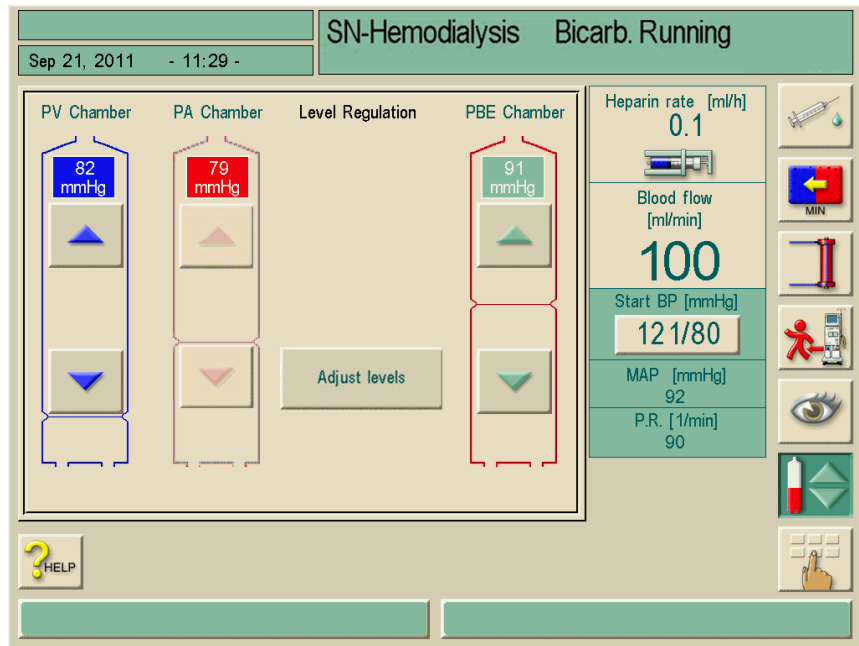

Fig. 9-4 Level regulation screen in single-needles

9



- Touch button
A supervisor window opens.

- Confirm by pressing the Enter key.
Blood pump stops automatically.
Pressure equalization is performed by opening the arterial and venous clamp.
The chambers are active and ready to adjust.



Level increasing

- Touch icon gently with one touch and observe level.
- Touch again for the correct setting if necessary.



Level decreasing

- Touch icon gently with one touch and observe level.



The level regulation is performed with the preset blood flow speed, but with a maximum of 400 mL/min.

- To determine the level regulation process, press button “Adjust levels”
or
- press level regulation icon.
Blood pump restarts automatically with preset values.





Risk to the patient due to infection by contamination of the manometer protection filter of the blood lines!

- Change manometer protection filter on the machine if the manometer protection filter of the blood lines has been in contact with blood.
- Call technical service for manometer protection filter change.



Risk of reduced dialysis effectivity!

- Ensure that no air enters into the dialyzer when decreasing the level in the arterial and in the PBE chamber.

9.1.3 Running the therapy



- Touch icon.
The dialysis machine switches to therapy mode.
- Confirm patient data, see section 6.1.
- Connect patient, see section 6.2.
- Fill tubing system with blood. Fill level in venous chamber to only approx. 35% in order to achieve a good phase volume.
- Start blood pump and slowly increase speed, depending on the vascular condition of the patient.

The dialysis is started.

During dialysis, the following phase volume should be reached:

- For standard AV set with 30 mL chamber: 12–18 mL
- For AV set for SN-clamp with 100 mL chamber: 15–25 mL

In order to change the phase volume, the control pressures can be set within certain limits, depending on the patient's connection conditions.

Recommendation

Lower venous control pressure min PV	Upper venous control pressure max PV
120 to 150 mmHg	up to 300 mmHg

- If necessary, change phase volume through control pressures min PV and max PV:
 - To increase the phase volume: Increase interval between **min PV** and **max PV**.
 - To decrease the phase volume: Decrease interval between **min PV** and **max PV**.
- Make certain the phase volume does not drop below 12 mL.
The phase volume reacts to:
 - Changes in the blood flow
 - Changes in the control pressures
 - Blood levels in venous chambers
 - Pressure changes in vascular access
- Observe level in venous chamber.
If necessary, change level via field **SN chamber level**.
- If necessary, adjust min. PV and max. PV, see section 6.7.
The optimum return flow time is set automatically.

9.1.4 Ending the therapy

The therapy ends automatically or after touching the respective icon, see section 7.2. Also observe the following steps.

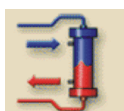

- Leave tubing segment of venous blood pump in venous blood pump.
- Always start reinfusion by pressing the appropriate icon.
- Disconnect patient, see chapter 7.



The level regulation system is not active during End of Therapy.

Table of contents

10	Use of accessories and options.....	10-3
10.1	ABPM blood pressure monitoring.....	10-3
10.1.1	Cuff	10-3
10.1.2	Settings.....	10-5
10.1.3	Starting/stopping measurement.....	10-8
10.1.4	Showing and graphically displaying measured values.....	10-9
10.2	Bicarbonate cartridge holder	10-10
10.2.1	Inserting the cartridge.....	10-10
10.2.2	Changing the cartridge during dialysis.....	10-11
10.2.3	Emptying the cartridge after treatment.....	10-14
10.3	Central concentrate supply	10-15
10.4	Adimea™ Option UV – Kt/V.....	10-16
10.4.1	Setting the parameters.....	10-17
10.4.2	Graphic representation during therapy	10-18
10.4.3	Target warning.....	10-20
10.4.4	Extended functionality when using the patient therapy card	10-21
10.4.5	Kt/V table.....	10-23
10.5	Dialysis fluid filter	10-24
10.5.1	Use and mode of operation.....	10-24
10.5.2	Changing dialysis fluid filter.....	10-25
10.5.3	Resetting the data	10-28
10.5.4	Disinfection.....	10-29
10.6	Emergency power supply/battery	10-30
10.6.1	Charging indicator	10-31
10.6.2	Automatic battery test	10-31
10.6.3	Ending battery operation.....	10-32
10.7	Communication interfaces	10-32
10.7.1	Dialog ⁺ computer interface (DCI)	10-32
10.8	Rinse bucket.....	10-32
10.8.1	Care of the rinse bucket.....	10-32

10 Use of accessories and options

10.1 ABPM blood pressure monitoring

The accessory ABPM (automatic blood pressure monitoring) allows non-invasive, oscillometric blood pressure measurements.

The blood pressure can be measured in the operating modes Preparation, Therapy and Disinfection.

ABPM blood pressure monitoring offers the following functions:

- Simple immediate measuring prior, during, and after the dialysis treatment.
- Clear display of blood pressure and pulse readings on the dialysis main screen
- Automatic, cyclic measuring
- Blood-pressure based individual limits adjustment on the press of a button
- Optional color display of blood pressure and pulse curves
- Documentation of readings with time stamps
- Readings outside the limits are marked in color



Risk of hematoma formation caused by frequent blood pressure measurements of patients who take coumarins or other anticoagulant substances!



The automatic blood pressure monitoring function does not release operators from the obligation to regularly monitor the patient.
The information transmitted and displayed by the option may not be used as the only source of information for the medical indication.

10.1.1 Cuff

The following cuffs can be used for ABPM blood pressure monitoring:

- Small (upper arm size 18 – 26 cm/7 – 10 inches)
- Medium (upper arm size 25 – 35 cm/10 – 14 inches)
- Large (upper arm size 33 – 47 cm/13 – 18.5 inches)

A "Medium" size cuff is supplied with every system delivered.

Applying the cuff



Infection risk to the patient due to a contaminated cuff!

- **When infectious (e.g. Hepatitis B) patients are treated, a separate cuff must be used for each patient.**

i

Cuffs distributed by B. Braun Medical Inc. are latex free.

Vent cuff prior to application. Compress cuff to let air escape.

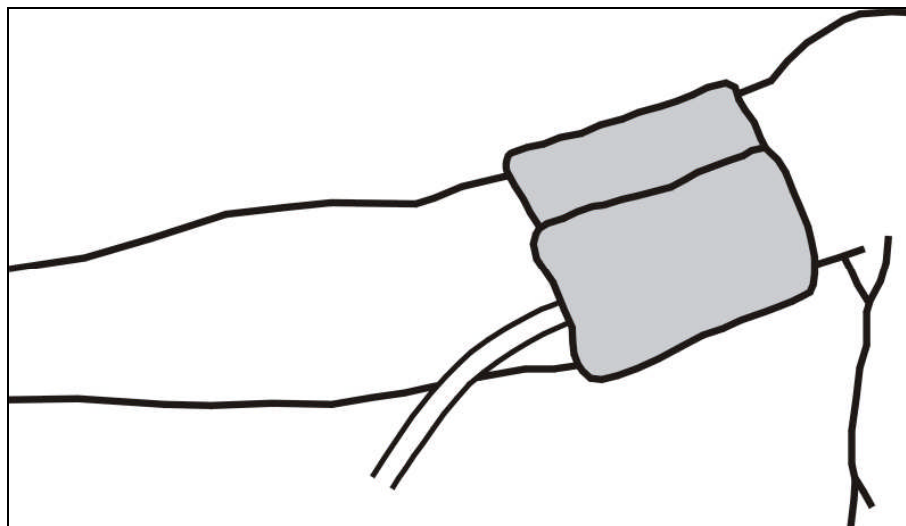

Fig. 10-1 Cuff

- Apply cuff securely in a suitable place around upper arm of the patient.
- Place marking on inside of cuff over artery.
- Ensure that cuff tube is not kinked.
- If applicable, set measuring cycle to the desired time interval (1-60 min, depending on the clinical situation).

!

- Do not apply cuff to limbs used for intravenous infusion or hemodialysis.
- Apply cuff securely, making certain that there is no venous flow-back or skin discoloration.
- Do not apply cuff in areas where blood circulation is impaired or where there is a risk of impairment to the blood circulation.
- Apply cuff as closely as possible to the forearm (approx. 2 cm/0.8 inches above the elbow).
- Using wrong cuff size can lead to wrong measurements.

Cleaning/sterilizing the cuff

- Ensure that no fluid enters the tube connections during cleaning.
- Only clean cuff with soapy water or an alcohol solution (e.g. Meliseptol®).

!

Never autoclave the cuff.

Sterilizing the cuff

Sterilize the cuff with ethylene oxide only.



Connecting the cuff tube to the dialysis machine

- Connect cuff tubing connection for blood pressure measurements at the dialysis machine. Ensure all connections are secured.

10.1.2 Settings



- Touch icon.
The settings menu appears.



- Touch icon.
The ABPM main view appears:

Legend

- 1 Set the alarm limits
- 2 Set the cycle time, in minutes
- 3 Activate/deactivate cyclical measurement
- 4 Start/stop ABPM

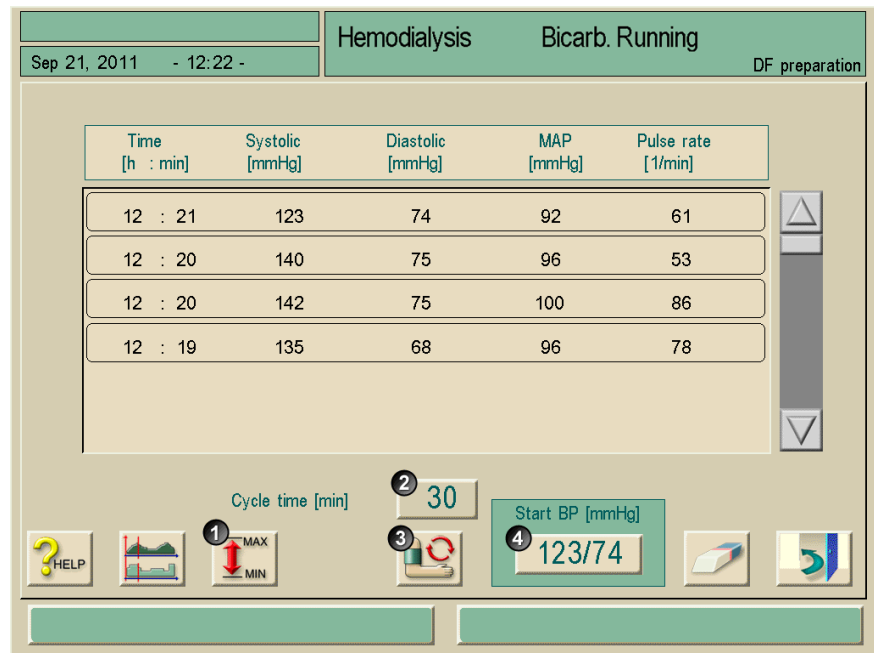

Fig. 10-2 "ABPM main view" screen

The window shows the data of the last two measurements:

- Time: Time (h:min)
- Systolic pressure: Systole (mmHg)
- Diastolic pressure: Diastole (mmHg)
- Mean pressure: MAP (mmHg)
- Pulse: Rate (1/min)

Setting for cyclical measurement

To set the measuring period (cycle time: 1 to 60 minutes), touch icon 2.

To activate or deactivate the cyclical measurements within the set time interval, touch icon 3.



The TSM allows a preset to determine whether the cyclic measurements are terminated by changing to Disinfection mode.

Setting the alarm limits

➤ To view and set the alarm limits, touch icon 1 (Fig. 10-2).

The following screen appears:

	lower	upper	
Systolic	80	220	[mmHg]
Diastolic	40	130	[mmHg]
Pulse rate	40	200	[1/min]

Buttons: ? HELP, Individual limit value adaption, [Navigation]

Fig. 10-3 "Alarm limits" screen

You can accept or adjust the alarm limits.

Option 1: Manual setting of alarm limits:

➤ Touch the limit to be set.

Enter new setting via the keypad.

Option 2: To set the alarm limit based on the last measuring result:

➤ Touch field Individual limit adaption.

New limit settings are suggested on a colored background.

➤ Confirm limit settings by pressing Enter key ↵ on the monitor.

Alarm limit values

Alarm limit	Lower	Upper
Lower limit systolic	50 mmHg	245 mmHg (but not higher than set upper limit systolic)
Upper systolic alarm limit	50 mmHg (but not lower than set lower limit systolic)	245 mmHg
Lower limit diastolic	40 mmHg	220 mmHg (but not higher than set upper limit diastolic)
Upper limit diastolic	40 mmHg (but not lower than set lower limit diastolic)	220 mmHg
Lower pulse rate	40 mmHg	200 mmHg (but not higher than set upper pulse rate)
Upper pulse rate	40 mmHg (but not lower than set lower pulse rate)	200 mmHg



After an initial measurement, the alarm limits should be set closer around the current blood pressure values.

The suggested alarm limits normally range around ± 30 mmHg, in critical areas at ± 10 mmHg around the last measured value.

To ensure best possible measurements, the cuff should be at heart level so that the measured blood pressure does not differ from the actual blood pressure due to the height difference.

10.1.3 Starting/stopping measurement

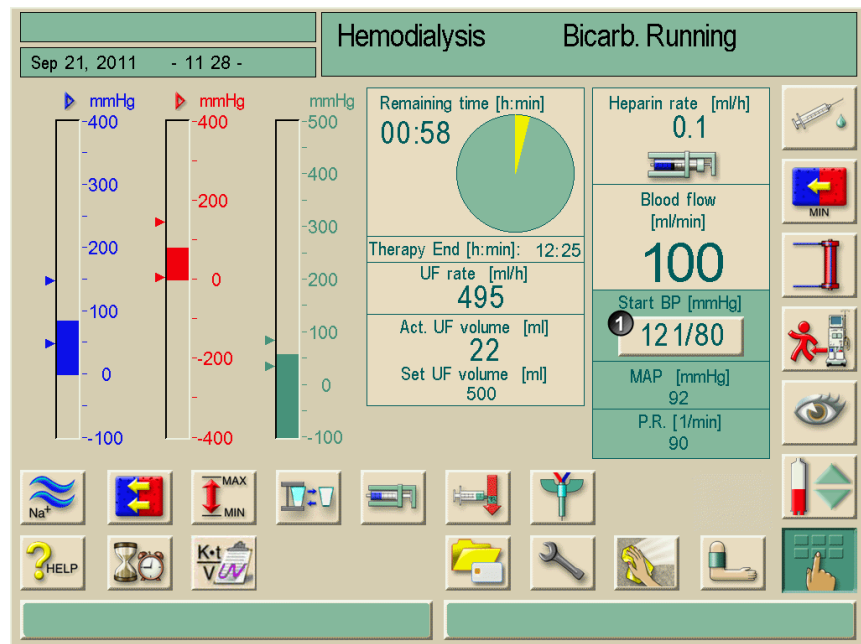

Fig. 10-4 "Therapy" screen

- Touch field 1 on the "Therapy" screen and field 4 in the "ABPM main menu" window (Fig. 10-2).

The last values measured for the systolic and diastolic pressure and the pulse rate are being displayed.

To stop an ongoing blood pressure measurement, touch the respective field again.

10.1.4 Showing and graphically displaying measured values

! Important!
 Erroneous measurements are marked with an asterisk in the first position. By activating a line with an asterisk, a window with the measuring results and an error description is called up.

i

When a measurement is canceled, the display field appears in yellow and shows "---/---".

The display field is also highlighted in yellow when the limits are exceeded.

In the measurement overview, all results are displayed with the respective time information. Values shown in red indicate that limits have been exceeded.

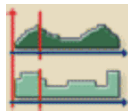

➤ Touch icon in "ABPM main menu" window (Fig. 10-2).
 The following screen appears:

Legend

- 1 Measured values at the time selected in field 4.
- 2 Cursor
- 3 Arrow fields for moving the cursor
- 4 Selected time
- 5 Switch on/off graphic display

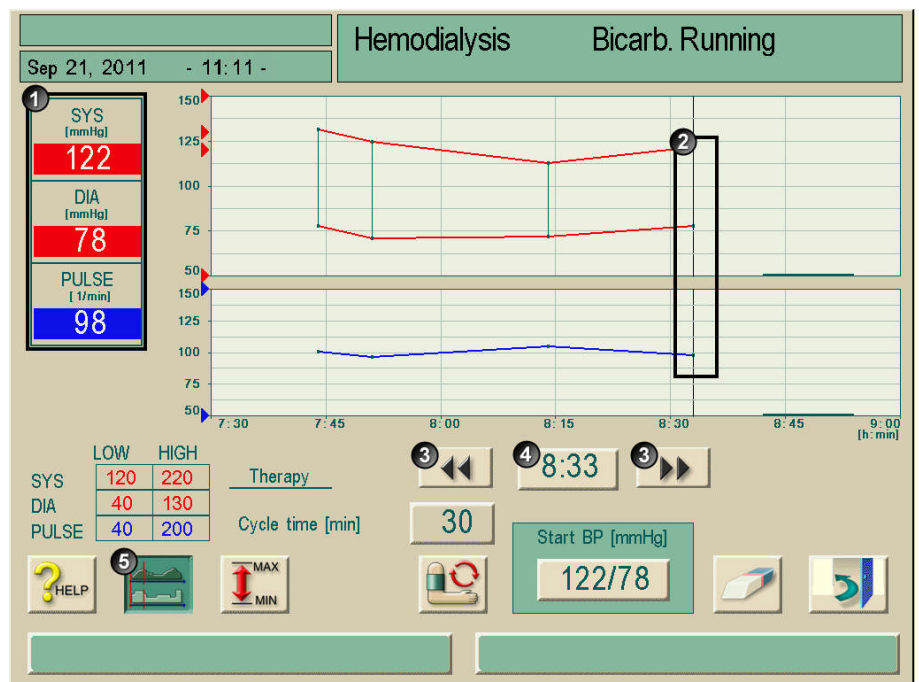

Fig. 10-5 Graphical representation of measured results

There are three different formats for graphic display.

➤ To switch between display formats: Touch number field 1 at left edge of screen.

10.2 Bicarbonate cartridge holder



Risk to the patient!

- Use only bicarbonate cartridges supplied by B. Braun Medical Inc. (e.g. Solcart B®) or bicarbonate cartridges that have been labeled for use with this dialysis machine.
- Never use cartridges containing substances other than bicarbonate.
- Never use bicarbonate cartridges containing acid concentrates for "Bicarbonate with NaCl".

i

- Review and follow bicarbonate cartridge datasheet.
- Ambient temperatures of > 35 °C/95 °F due to direct exposure of the bicarbonate cartridge to sunlight or large temperature differences between storage and treatment rooms can lead to increased gas formation in the cartridge. This may trigger an alarm, or the bicarbonate content in the dialysate may deviate slightly from the specified value.
- When using a bicarbonate cartridge, the concentrate rod for the bicarbonate remains in the machine. As soon as holder is opened, the dialysis machine detects that a cartridge is to be used.

10.2.1 Inserting the cartridge



Fig. 10-6 Inserting a cartridge

- Press in lateral button at top fixture and pull up top fixture as far as it will go.
- Using your left hand, place cartridge between top and bottom fixtures. At the same time, place inlet and outlet necks of cartridge into their respective recesses at the top and bottom fixtures.
The lever at the top fixture is automatically pushed back in the process.
- To close the cartridge holder, press top fixture centrally onto the cartridge.
The cartridge is pierced, automatically vented and filled with permeate.



CAUTION

Crushing hazard!

- **When closing the cartridge holder, do not bruise hands or fingers!**



CAUTION

Risk of injury!

- **When closing the cartridge holder, do not reach between top and bottom holder.**

10.2.2 Changing the cartridge during dialysis

When the cartridge is empty, the bicarbonate conductivity alarm is triggered and an information window appears. An almost empty cartridge can be replaced before an alarm is activated.

The preferred method for draining the cartridge must be selected in TSM service program.

To drain cartridge

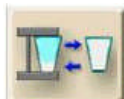

- Touch icon.

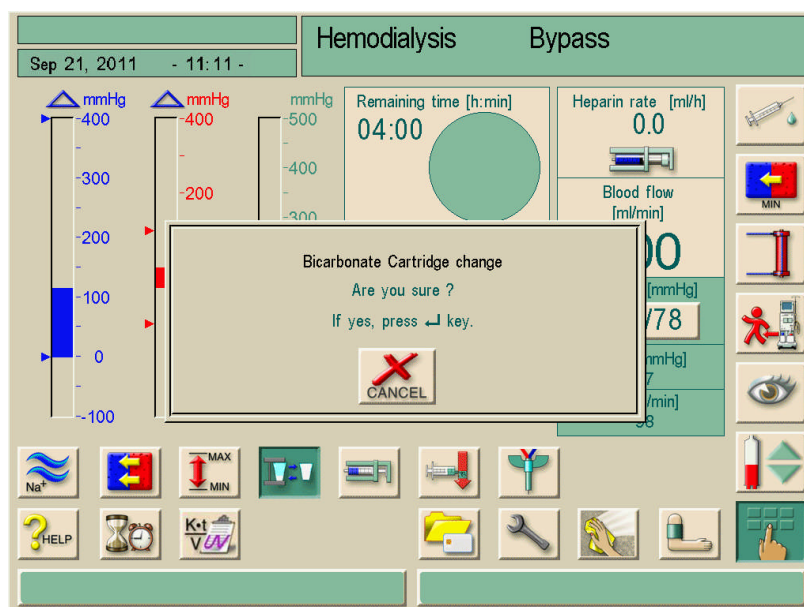

Fig. 10-7 Bicarbonate cartridge change

- A confirmation window appears, confirm by pressing the Enter key ↵.
- The cartridge will be drained (if Bic cartridge with draining is selected in TSM).
An information window appears after a few seconds.

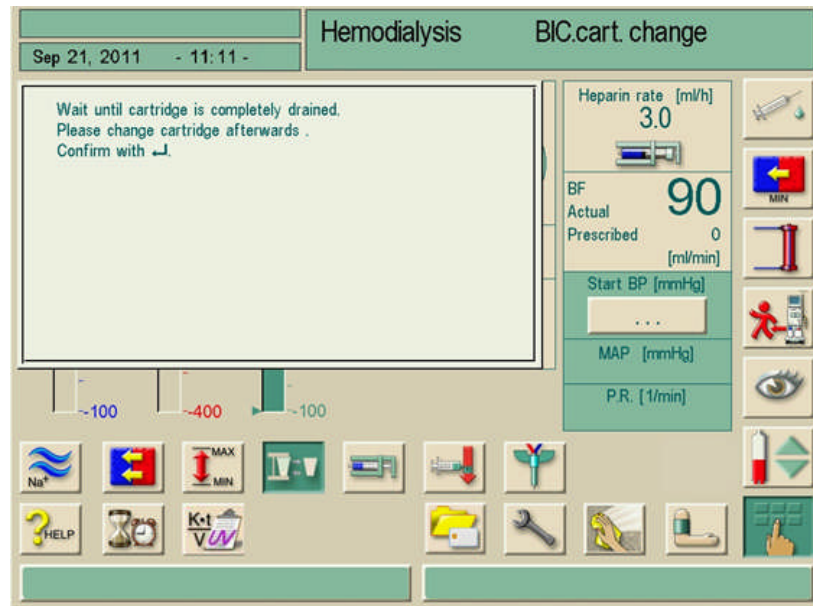
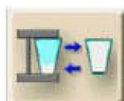

Fig. 10-8 Bicarbonate cartridge change with draining

- Insert new cartridge.
- After inserting the new cartridge, confirm by pressing the Enter key ↵.
The machine prepares the new Bic cartridge.

To change cartridge without draining



➤ Touch icon.

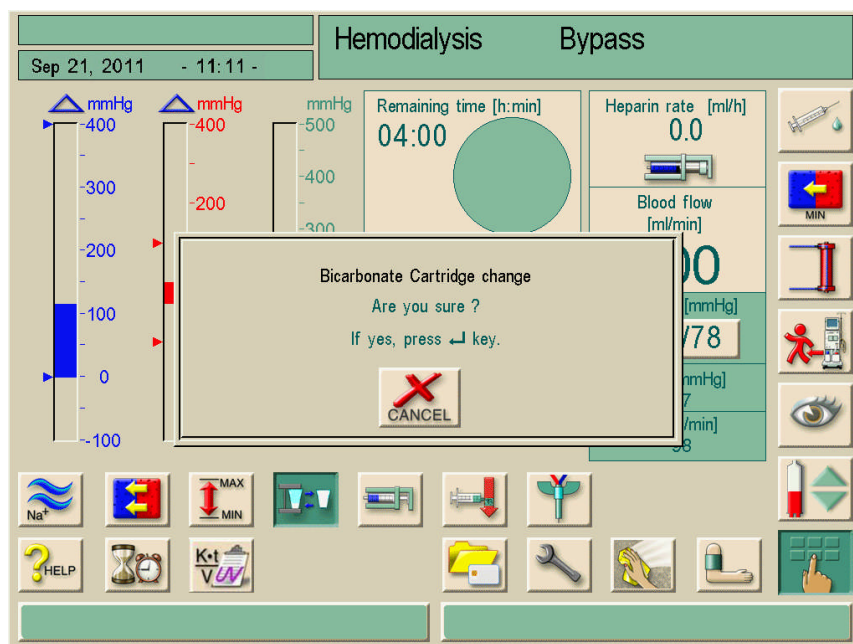

Fig. 10-9 Bicarbonate cartridge change

- A confirmation window appears, confirm by pressing the Enter key ↵.
- The cartridge will not be drained, only the pressure will be released (if Bic cartridge without draining is selected in TSM service program).
- An information window appears when the empty cartridge can be taken out.

10

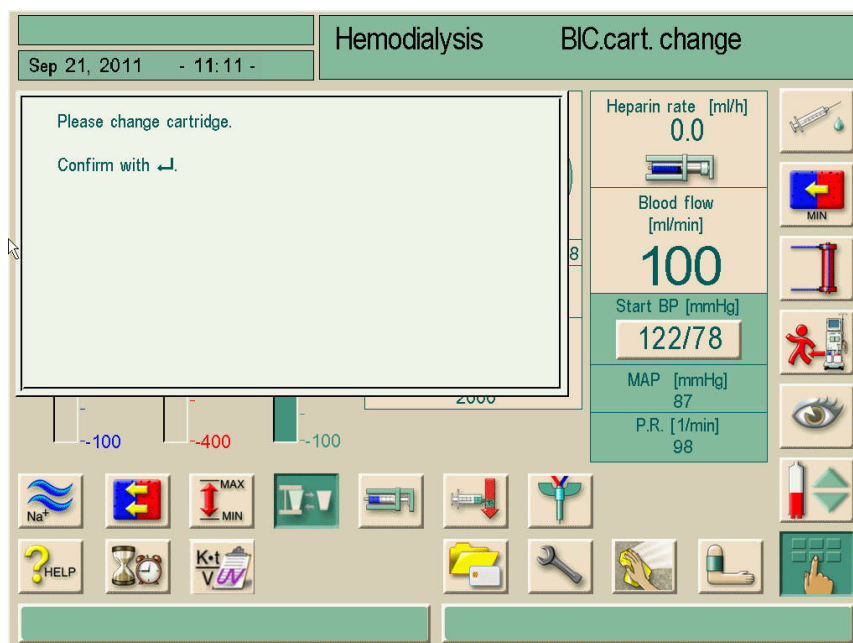

Fig. 10-10 Bicarbonate cartridge change without draining

10.2.3 Emptying the cartridge after treatment



- Touch icon and confirm by pressing the Enter key ↵ on the monitor. The cartridge is emptied automatically.



Emptying of cartridge must be performed before emptying of dialyzer.

10.3 Central concentrate supply

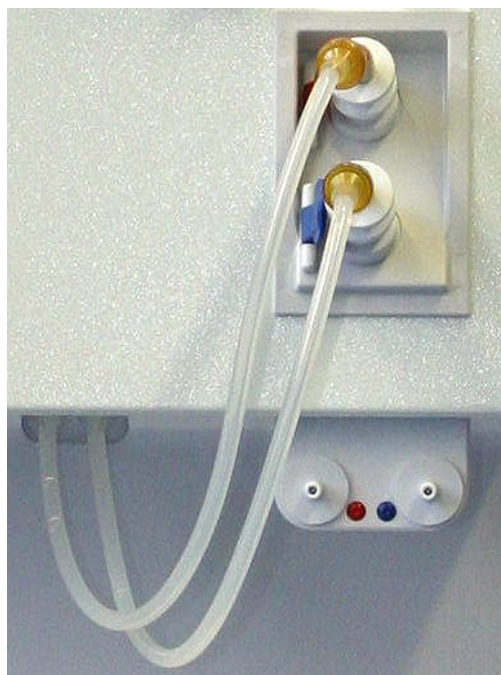

Fig. 10-11 "Central concentrate supply" connections

When using a dialysis machine equipped with the "Central concentrate supply" accessory, the concentrate (acetate or bicarbonate components) does not have to be provided in containers but can be obtained from the central supply. Both components can be obtained centrally or individually from containers. Another option is combining a bicarbonate cartridge with acid components from central concentrate supplies.

To connect the concentrate, place couplings of suction rods onto connections of the central concentrate supply,

The concentrate connections of the dialysis machine are thus directly connected to the wall connections of the central concentrate supply.

10.4 Adimea™ Option UV – Kt/V

Adimea measures UV Kt/V by obtaining the slope of the dialysate spectro-photometric absorbance curve over time. Because there is a close linear relationship between the UV absorption signal and urea levels in dialysate, Adimea can be used as a surrogate marker for urea.

Adimea's Kt/V projection feature is designed as a graphical display for use by the operator as a qualitative indicator of therapy effectiveness that can be accessed at any given time during the course of the treatment. Because of its qualitative nature, no accuracy or projected value of blood Kt/V are displayed on the machine's interface. It is not intended to be used as a direct measure of blood Kt/V which should continue to be carried out by the traditional method of obtaining the patient's blood BUN level on a monthly basis and calculating for Kt/V.

Two calculation methods are available for calculation of Kt/V and URR:

- Single pool Kt/V (spKt/V)
- Equilibrated Kt/V (eKt/V)

The selection is performed once in TSM mode. The calculation method set is displayed on the screen.



Risk to the patient by the input of new treatment parameters.

- **Ensure that the change of the treatment parameters corresponds with the prescription of the physician.**



Risk to the patient by the input of new treatment parameters.

- **The treatment parameters may not be determined on the basis of the measured Kt/V.**
- **A measurement of the Kt/V does not replace the therapy prescribed by the physician.**



Risk of over or under estimation of Kt/V in pediatric patients!

- **Do not use the Adimea option UV-Kt/V for pediatric patients, since the accuracy of this optional feature has not been proven or validated in the pediatric population.**



If the option Adimea is selected, the theoretical calculation of the effectiveness as described in chapter 4.4 is not applicable.



If single-needle mode is selected, the Adimea Option is not available.

The Adimea option UV-Kt/V is an online measuring method to determine the effectiveness of the dialysis treatment. The concentration of waste products in the dialysate is measured by means of UV light, and the Kt/V value as well as the urea reduction ratio (URR) are calculated from these measured values.

10.4.1 Setting the parameters

- Input of patient weight before dialysis (Fig. 10-12, 1). Setting the parameter enables the calculation and display of Kt/V, URR and UV absorption.
- Input/adaptation of the target Kt/V value (Fig. 10-12, 2).
- Enable/disable target warning (Fig. 10-12, 3). If the target warning is enabled, the system informs the user whether the target value will possibly not be reached at the end of therapy. In that case the user can adapt the parameters in order to reach the determined dialysis dose.
- The user can directly access three parameters which influence the Kt/V without changing the menu. Those are therapy time, blood flow and dialysate flow. Influences on curves and values will be displayed after a short processing time.

The introduction of the patient weight and, therefore, the activation of the Kt/V measuring function can be done at any time during therapy. The displayed Kt/V and URR and UV light absorption always consider the already achieved dialysis time.

Legend

- 1 Input of patient weight before dialysis
- 2 Input/adaptation of the target Kt/V value
- 3 Enable/disable target warning

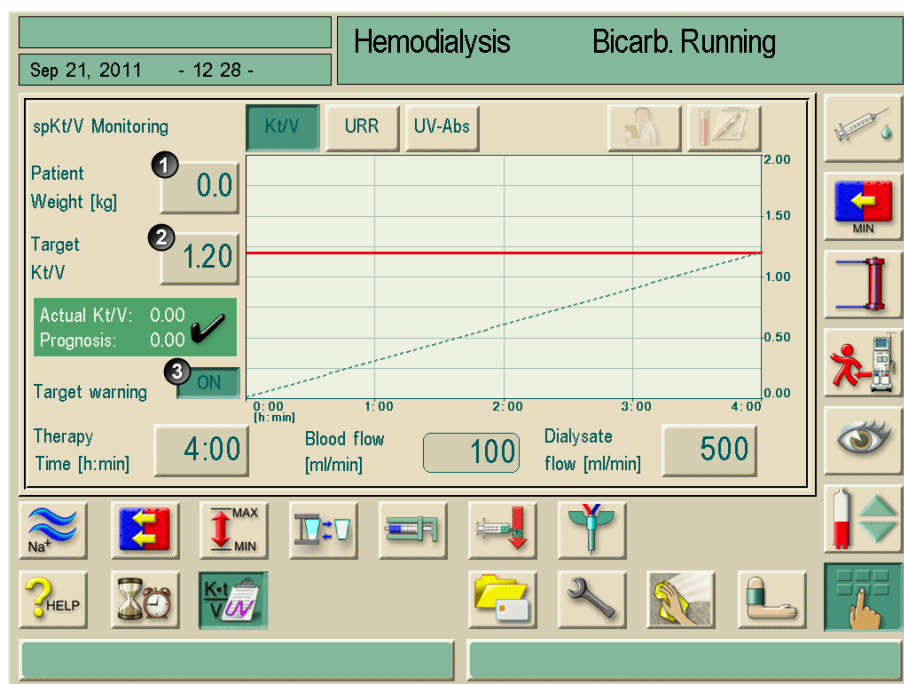



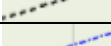



Fig. 10-12 Setting parameters

10.4.2 Graphic representation during therapy

- By touching the icons "Kt/V" and/or "URR" and/or "UV absorption" it is possible to change between the parameter display. A graphical and numerical overview of the current therapy is displayed on the respective screen.
- A blue line represents the actual progress of the respective parameter until the respective time of therapy.
- A green dashed line serves as orientation for the user to see whether the actual therapy progress will fulfill the target dialysis dose. If the blue curve is above the green dashed one, the target Kt/V will probably be reached at the end of therapy.

Explanation of colored lines

Red line		Target value at the end of therapy
Blue line		Actual progress line Kt/V, URR or UV absorption
Green dashed line		Orientation line of complete therapy
Black dashed line		Previous completed therapy (new feature)
Blue dashed line (extension of blue line)		Prognosis

Legend

- 1 Chose Kt/V and/or URR and/or UV absorption
- 2 Actual progress line of the Kt/V (graphical display) and actual Kt/V value (numerical display)
- 3 Orientation line of complete therapy

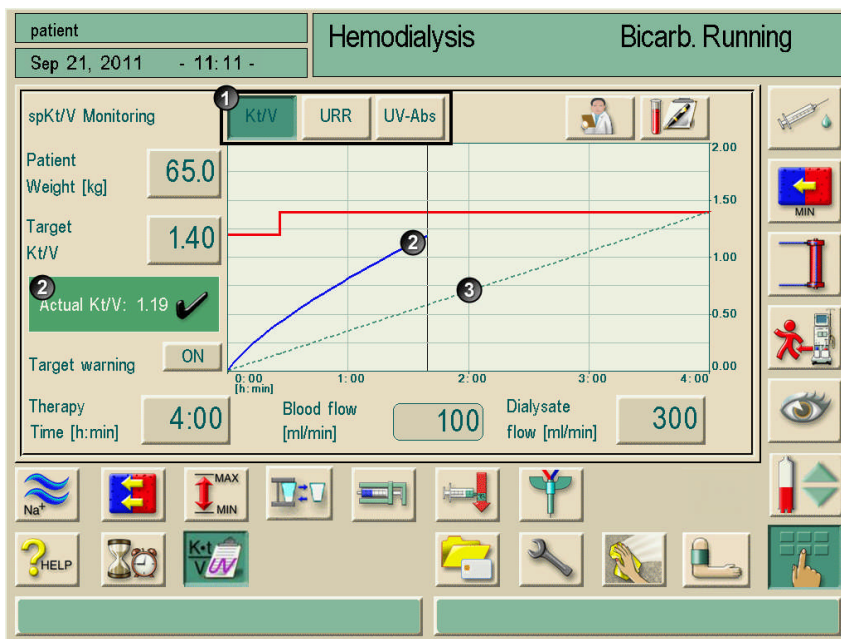

Fig. 10-13 Graphical display

i

In hemodialysis (HD) mode the user gets a “prognosis” of the estimated Kt/V value at the end of therapy. It is displayed numerically (Fig. 10-14, 1) and graphically (Fig. 10-14, 2). The blue actual progress line will be extended from the actual therapy status in order to predict the therapy progress.

This functionality is not available in Single-needle mode.

10

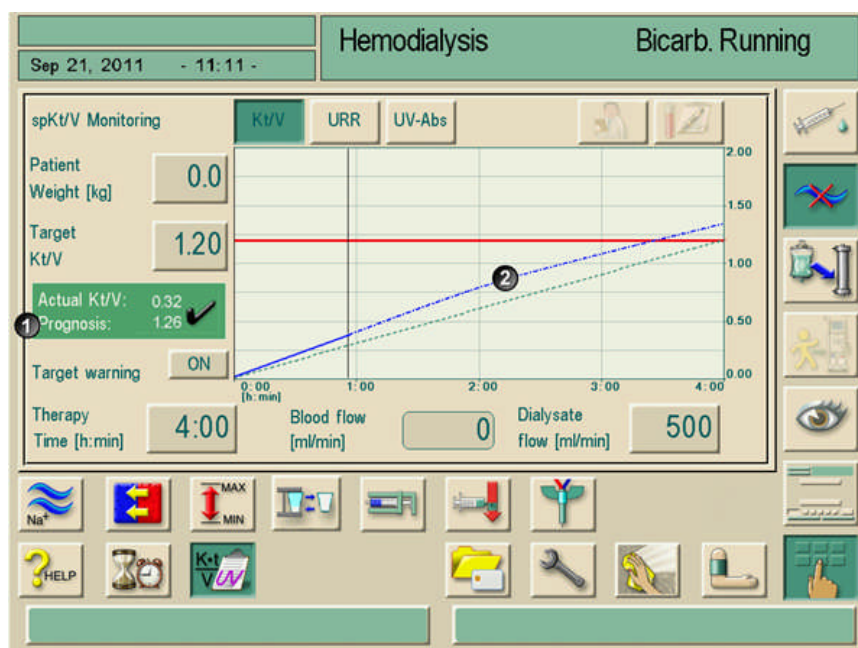

Fig. 10-14 Numerical and graphical display of the prognosis

10.4.3 Target warning

If the “Target warning” is enabled, the machine will inform the user showing a yellow warning on the screen in case that either Kt/V resp. URR will not be reached at the end of therapy.

The warning is displayed if either the blue actual progress line (Fig. 10-15, 1) has already been below the green dashed orientation line (Fig. 10-15, 2) or if it could fall below it within the remaining therapy time (Fig. 10-16).

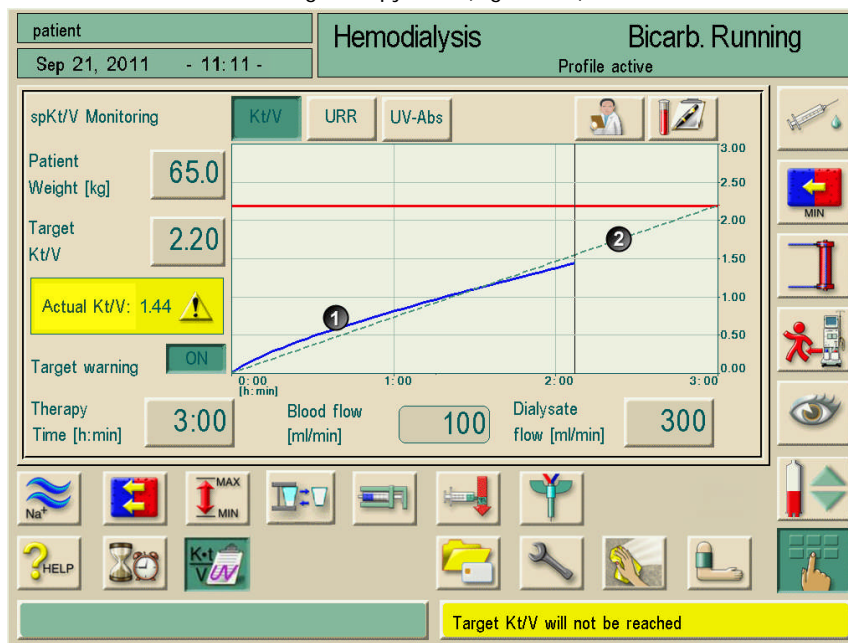

Fig. 10-15 Graphical display of blue actual progress line below green dashed orientation line

In the second case the blue line (Fig. 10-16, 1) will be extended by a red dashed line (Fig. 10-16, 2) predicting that the target value will not be reached.

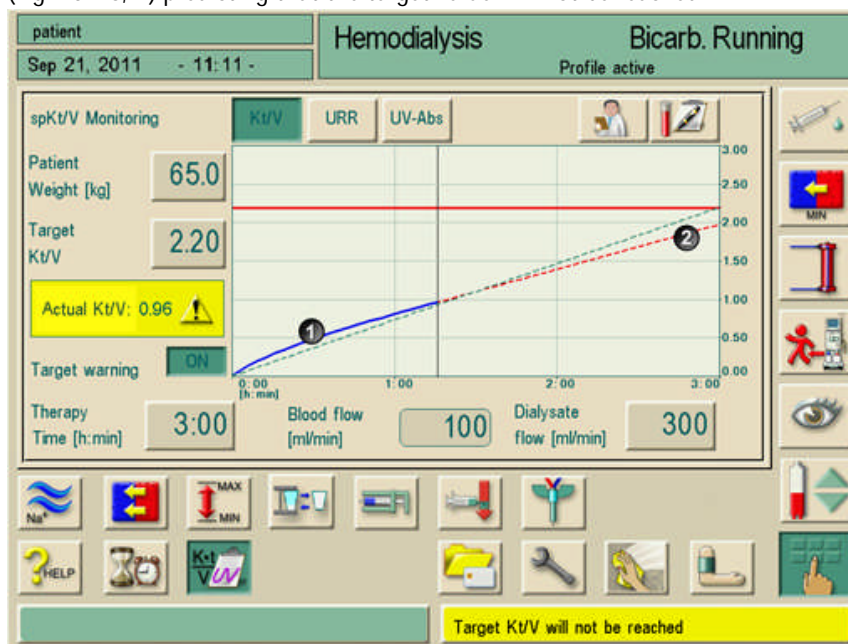

Fig. 10-16 Graphical display of parameters at the end of therapy

Adapt the parameters according to the following table:

	Text	Range	Description
1	Kt/V target value	0.00 – 3.00	Input of a Kt/V target value
2	Therapy time	1 hours – 10 hours	-
3	Dialysate flow	300 mL/min – 800 mL/min	-
4	Blood flow	50 mL/min – 600 mL/min	Adjustment via the +/- keys on the monitor

10.4.4 Extended functionality when using the patient therapy card

Using the patient therapy card allows to store the patient's individual Kt/V parameters and graphic Kt/V or URR therapy progresses. Therefore, data are still available for the user after the end of therapy. It is possible to store up to 12 completed therapies and to compare them graphically or to evaluate Kt/V and URR values of up to 50 completed therapies. Trends or unusual therapies can be identified and analyzed if necessary.

The graphical display will be shown by touching the respective icons.



➤ Touch the icon.

Up to 12 completed therapies are displayed:

10

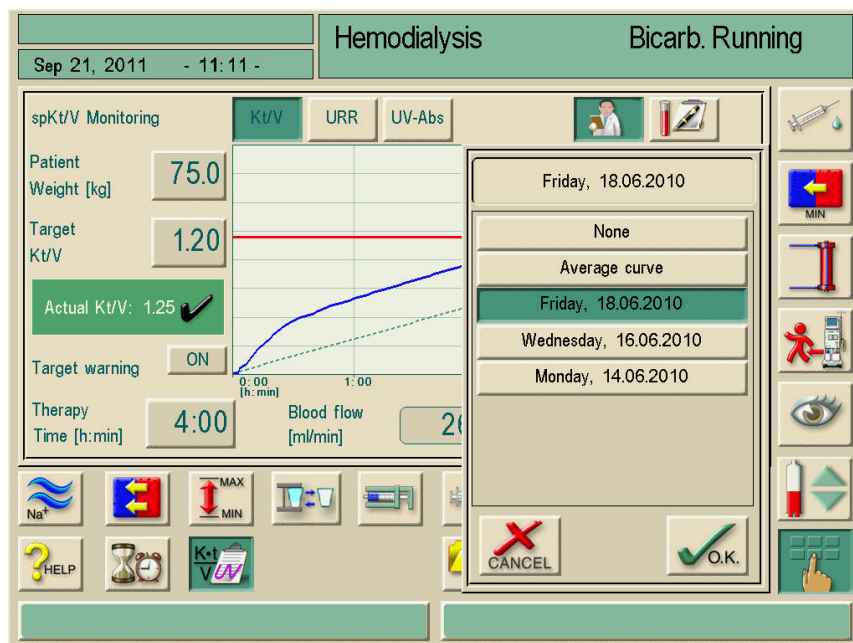

Fig. 10-17 Display of up to 12 stored therapies

Wednesday, 18.08.2010

- By touching one of the displayed therapies the screen showing the black dashed progress line (Fig. 10-18, 1) opens:

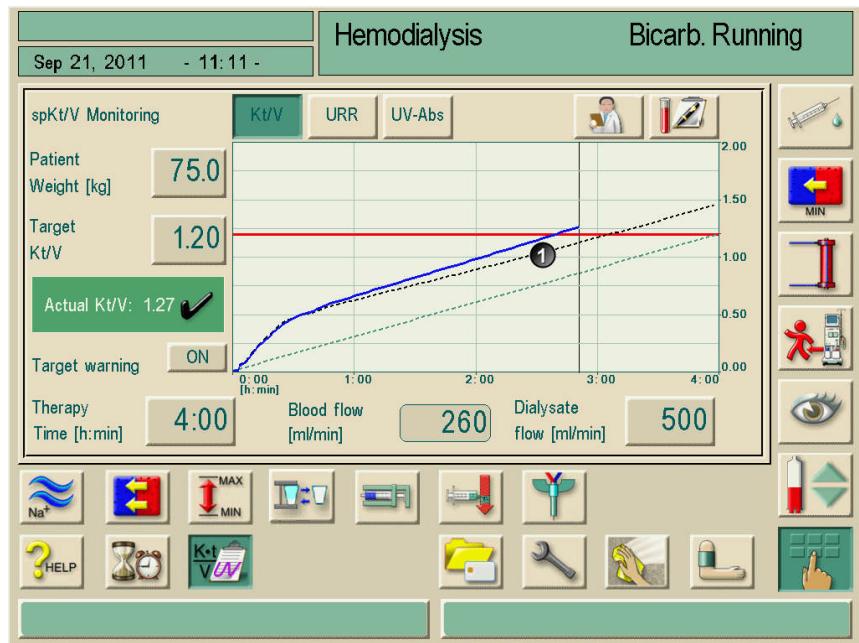

Fig. 10-18 Display of the black dashed progress line

10.4.5 Kt/V table

- Touch the icon.

The data are read from the therapy card and displayed on the screen



patient		Preparation		Rinsing with UFP													
Sep 21, 2011 - 11:11 -																	
1	Therapy date and time [dd.mm.yyyy h:min]	2	Target Kt/V [-]	3	Patient weight [kg]	4	IS-therapy time [h:min]	5	Average blood flow [ml/min]	6	Average dialysate flow [ml/min]	7	IS-URR [%]	8	IS-Kt/V [-]	9	spKt/V
	28.01.2008 17:49	1.40	65.3	04:05	238	496	77	1.47									
	25.01.2008 14:04	1.40	66.1	04:05	244	500	89	1.48									
	22.01.2008 08:59	1.40	65.0	02:20	79	300	73	1.32									

Fig. 10-19 "Kt/V Table" Screen

	Text	Description
1	Therapy date and time [dd.mm.yyyy, h:min]	Date and time of performed therapies
2	Target Kt/V [-]	Set Kt/V target value
3	Patient weight [kg]	Patient weight before dialysis
4	ACTUAL therapy time [h:min]	Actually performed therapy time
5	Average blood flow [mL/min]	Average blood flow over the therapy period
6	Average dialysate flow [mL/min]	Average dialysate flow over the therapy period
7	ACTUAL URR [%]	Achieved urea reduction ratio
8	ACTUAL Kt/V [-]	Reached Kt/V value
9	Calculation method (spKt/V, eKt/V)	Set calculation method



- Touch the icon to exit the display.

10.5 Dialysis fluid filter

10.5.1 Use and mode of operation

The dialysis fluid filter is a hollow-fiber filter. It is used as a bacterial and pyrogen filter for performing hemodialysis therapy with highly pure dialysate. Even if the machine has been correctly cleaned and disinfected, the permeate and the bicarbonate concentrate, which, unlike the acid-containing concentrate, is not sterile, can be the source of possible contamination.

For additional information refer to the Instructions for Use for Diacap[®] Ultra dialysis fluid filters.



Risk to patients due to uncontrolled fluid withdrawal!

- External leakages on the filters (e.g. faulty tube connections) will affect the UF control system of the dialysis machine!
- Prior to each treatment, visually inspect filters for external leakages.



Time of filter change

See relevant data sheet for the specified service life of the dialysis fluid filter in use.

The filter must be changed, when

- the number of therapies set in the service program has been reached,
- the set number of operating hours has been reached,
- the test of the dialysate system during preparation has not passed and leakages are discovered at the filter.



The dialysis fluid filter may only be operated with permeate or dialysate.

The following warning message appears when the DF filter has reached the preset setting in TSM:

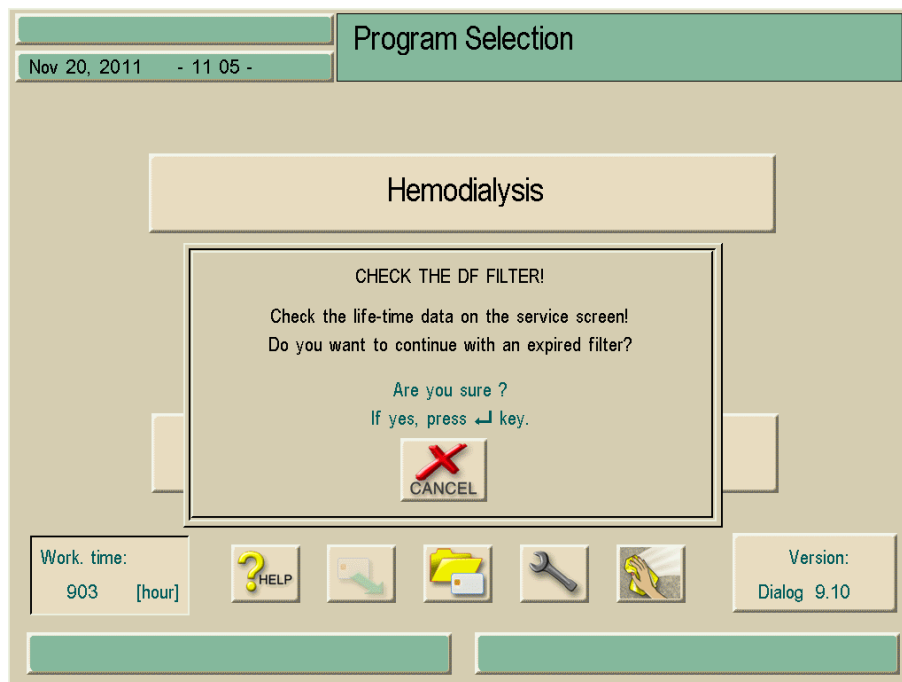

Fig. 10-20 "Filter change" warning window

10.5.2 Changing dialysis fluid filter

The dialysis machine supervises remaining operating hours of the filter as well as performed therapies. Operating hours are hours in Therapy as well as hours in Preparation and Disinfection.

When either the operating hours or the number of therapies are reached, a warning window will be displayed on the screen. It informs the user about the upcoming filter change. The warning window appears when 60 operating hours or 10 therapies remain. It is displayed when the user changes from Program Selection to Preparation and it lasts for 1 minute.

It is recommended to change the filter after 150 therapies or 900 operating hours.

Preconditions

- No patient connected to dialysis machine
- Dialysis machine switched on.
- Screen Disinfection selection is displayed, no disinfection program started (machine is in rinse out, see Fig. 10-21)



Risk to the patient!

- Only use dialysis fluid filter Diacap® Ultra by B. Braun Avitum AG or dialysis fluid filters that have been labeled for this dialysis machine by the respective manufacturer.



- Touch icon while in disinfection screen.
A screen is displayed.

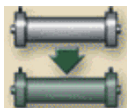

- Touch icon.
The following screen is displayed:

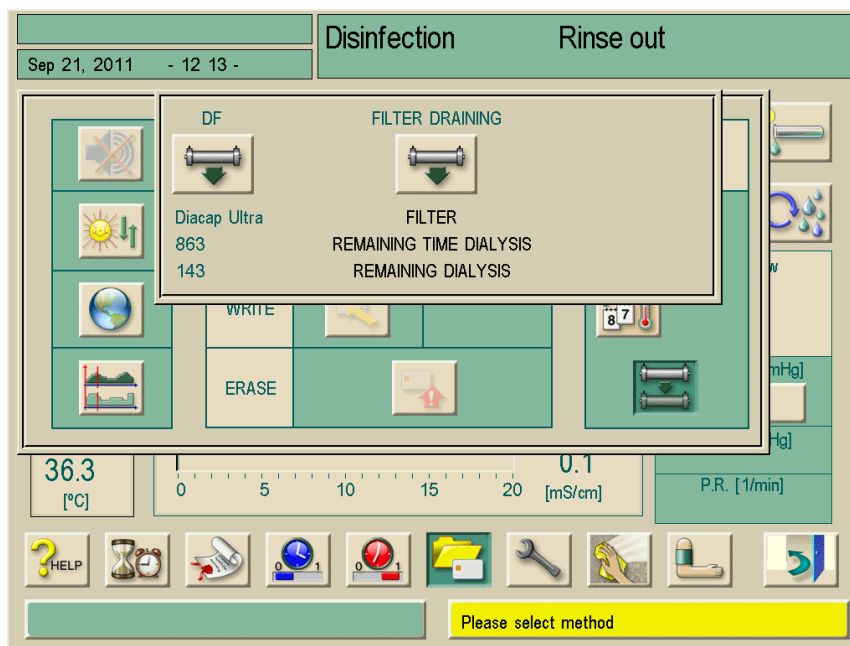
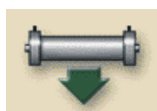

Fig. 10-21 "Filter draining" warning window

The remaining dialysis time and the number of performed dialyses are displayed.

- Touch the "FILTER DRAINING" icon.
A prompt to remove the dialyzer feed connector is displayed.



- Remove the dialyzer feed connector
The filter is drained and vented. After approx. 90 seconds, the message "DF filter drained" is displayed.

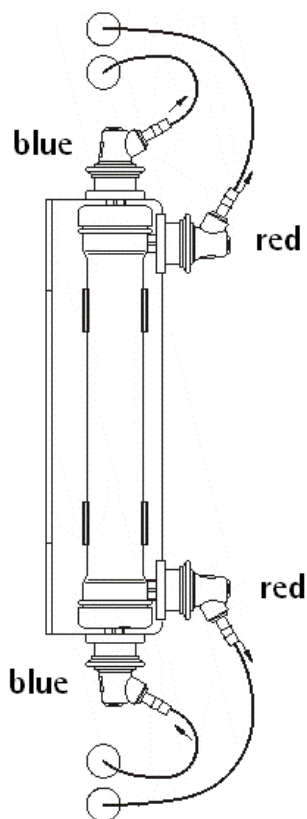

Fig. 10-22 Dialysis fluid filter

- Remove all couplings (red and blue) from the filter. Catch the fluid escaping in the process.
- Hold old filter centrally and remove it from the clamping brackets of the filter holder.
- Hold new filter centrally and press it into the clamping brackets of the filter holder.
- Push blue couplings onto dialysate couplings on the filter caps.
- Push red couplings onto lateral dialysate connections.
- Reset data with the dialysis machine switched on.



Perform a disinfection cycle after installation/change of the filter.
 It is recommended to record the installation/change of the dialysis fluid filter in the machine logbook (date, batch number).
 The Operating time and Number of dialyses data must be reset.

10.5.3 Resetting the data

Preconditions

The dialysis machine is switched on.

The disinfection selection screen is displayed.



➤ Touch icon.

A screen appears.

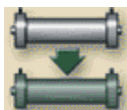

➤ Touch icon.

The following screen appears:

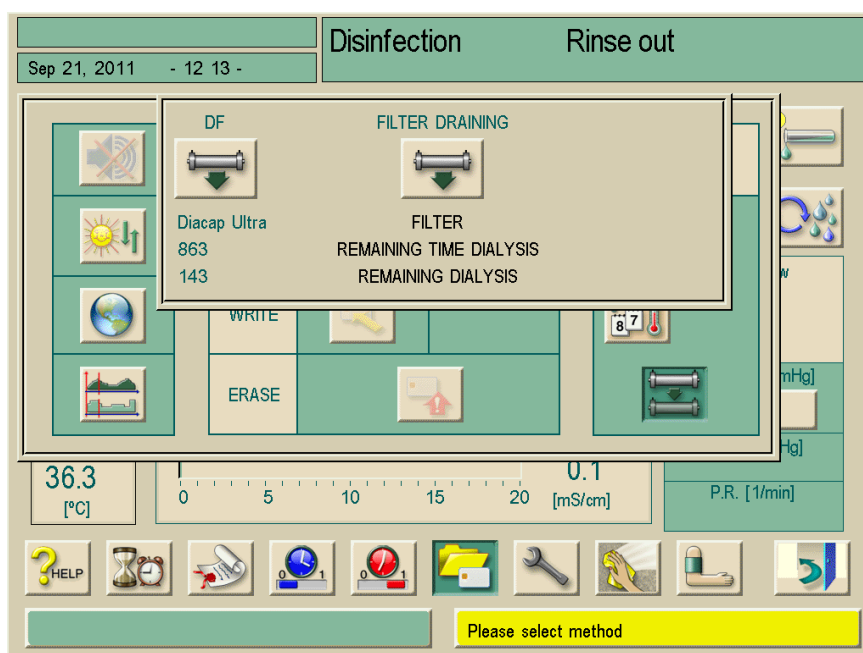
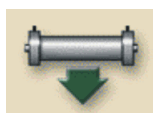

Fig. 10-23 "Select Disinfection" screen with active window "Filter change"



➤ Touch icon to reset operating time and number of dialysis.

➤ Confirm query by pressing the Enter key ↵ on the monitor.

10

10.5.4 Disinfection

The dialysis fluid filter is a fixed part of the dialysis machine for the entire duration of its use. It is cleaned and disinfected together with the dialysis machine.

Suitable disinfectants

The following agents are suitable for disinfecting the dialysis fluid filter Diacap® Ultra:

- Citric acid 50% (heat disinfection)
- Paracetic Acid



WARNING

Unsuitable disinfectants may cause changes to the material characteristics of the housing, encapsulation and capillaries of the filter!

Risk to the patient! The dialysis machine is no longer safe to operate!

- Only use suitable disinfectants.
- Check information leaflet supplied with filter.
- Before using other disinfectants contact B. Braun Medical Inc. service technicians.

**Unsuitable disinfectants**

The following substances may **not** be used for disinfecting the dialysis fluid filter:

- Chlorine-containing fluids and organic solvents, e.g. chloroform, acetone, ethyl alcohol
- Alkaline solutions, e.g. sodium hypochlorite (bleach)

The manufacturer will not accept any liability if unsuitable disinfectants are used.



WARNING

There may be a risk of uncontrolled UF withdrawal from patient due to a calcified dialysis fluid filter.

- To prevent this, perform decalcification with Citric Acid 50% after each treatment.
- Alternatively, the automatic descaling function can be performed after each treatment if activated in TSM.

10.6 Emergency power supply/battery

The battery operation mode serves to maintain the extracorporeal blood circulation in case of a power failure.

In such an event, the dialysis machine automatically switches to battery operation.

- "Battery/bypass" will be displayed in the status line.
- The remaining battery life is shown in the patient name field.
- This is followed by an acoustic signal.
- The alarm message "Power failure – battery operation" is displayed.

This message must be confirmed.

Active functions during battery operation

The following functions and monitoring devices are active during battery operation:

- Screen and control elements
- All blood-sided functions and alarms
- Blood pumps
- Tube clamps
- Air detector SAD
- Heparin pump
- Blood pressure monitoring
- Single-needle operation

In the "end" mode, all blood-side functions are active during battery operation as well as during mains operation. If necessary, the patient can be disconnected in the usual way.

Functions not available during battery operation

The following functions are not available during battery operation:

- Dialysate treatment
- Ultrafiltration
- Emptying the dialyzer and cartridge
- Rinsing, disinfecting

Battery operating time



After a successful automatic battery test, the battery has an operating time of at least 20 minutes.

When power fails repeatedly, the battery will function for the residual operating time after each power failure.



Switching off in battery operation

If the equipment is switched off in battery operation, it can not be switched on again after a time span of 16 minutes unless it is connected to the mains.

10.6.1 Charging indicator

An indicator light in the keyboard membrane of the screen indicates that the battery is being charged while the system is operating on mains power. Battery charging continues even when the machine is switched off. The indicator light goes dark as soon as the battery is fully charged.

10.6.2 Automatic battery test

During the automatic machine test performed at each call-up for dialysis, the battery function is tested too. In case of an unsuccessful automatic test, an information message appears. The test could be unsuccessful for the following reasons:

Cause	Action
Battery not fully charged, e.g. because the machine has not been connected to mains power for some time.	➤ Charge battery.
Faulty battery.	➤ Inform technical service.
Fuse of battery has been triggered due to a technical defect.	➤ Inform technical service.

Dialysis after an unsuccessful automatic battery test



Dialysis can be started although the battery self-test was not passed. The battery is charged. Take into account that battery operation is not available or only available for a limited time during a mains power failure.



Battery change

To maintain the battery functionality, we recommend replacing the battery at least every 5 years. For correct disposal of the battery please refer to service manual.



Risk to the patient due to blood loss.

- When blood flow stops, clotting may occur due to mains power failure resulting in a loss of the patient's blood.
- Return blood to patient manually. (See chapter 13.4.)

10.6.3 Ending battery operation

As soon as the mains power supply has been restored, the battery operation is automatically ended. The dialysate treatment is activated again. Once the unit has adjusted itself to the set values, dialysis is automatically continued. User intervention is not required.

10.7 Communication interfaces

The dialysis machine has a RS232 communication interface for communicating with other information systems.

10.7.1 Dialog⁺ computer interface (DCI)

The Dialog⁺ computer interface allows transferring various parameters to other EDP (Electronic Data Processing) systems installed on the ward.

For further information see the Instructions for Use for the Dialog⁺ computer interface.

10.8 Rinse bucket

10.8.1 Care of the rinse bucket

The recommended positioning of the rinse bucket is above the level of the venous drip chamber on the IV pole or mounted on the screws at the side of the machine housing. Placing the rinse bucket in a position lower than the venous drip chamber alters the pressure inside the drip chamber and may cause venous pressure alarms and difficulty filling the drip chamber.

After the treatment has been initiated, the rinse bucket should be emptied into a dirty sink and rinsed with clean water and returned to the machine. At the end of therapy, the outside and inside of the rinse bucket should be disinfected along with the external surfaces of the machine as per clinic policy and procedure.

Table of contents

11	Configuration	11-3
11.1	Automatic switch-off	11-3
11.2	Weekly disinfection program	11-5
11.3	Configuring the weekly disinfection program.....	11-6
11.4	Configuring profiles	11-9
	11.4.1 Basic principles	11-9
	11.4.2 Setting profile parameters	11-9
11.5	UF profiles.....	11-11
	11.5.1 Selecting UF profiles	11-11
	11.5.2 UF profile table	11-13
11.6	Patient therapy chip card.....	11-18
	11.6.1 Erasing data from patient therapy card	11-18
	11.6.2 Entering the patient name	11-19
	11.6.3 Reading patient data	11-20
	11.6.4 Storing patient data (parameter settings).....	11-20
11.7	Theoretical Kt/V calculation	11-21
11.8	Adjusting monitor brightness.....	11-26
11.9	Selecting language of screen text.....	11-27
11.10	Editing trend group parameters	11-28

11 Configuration

11.1 Automatic switch-off

If the automatic switch-off function is activated, the machine will switch-off automatically after each manually started disinfection. A time-out can be set by the user.

Example:

Time-out 45 min -> the machine will switch-off 45 min after the disinfection is completed, if there is no user action during the time out.

The automatic switch-off function is independent from the weekly disinfection program.

Legend

- 1 Select disinfectant
- 2 Thermal disinfection
- 3 Chemical disinfection
- 4 Short chemical disinfection
- 5 Rinse permeate inlet
- 6 Chemical disinfection with disinfection solution from central water supply
- 7 Thermal disinfection with hot permeate

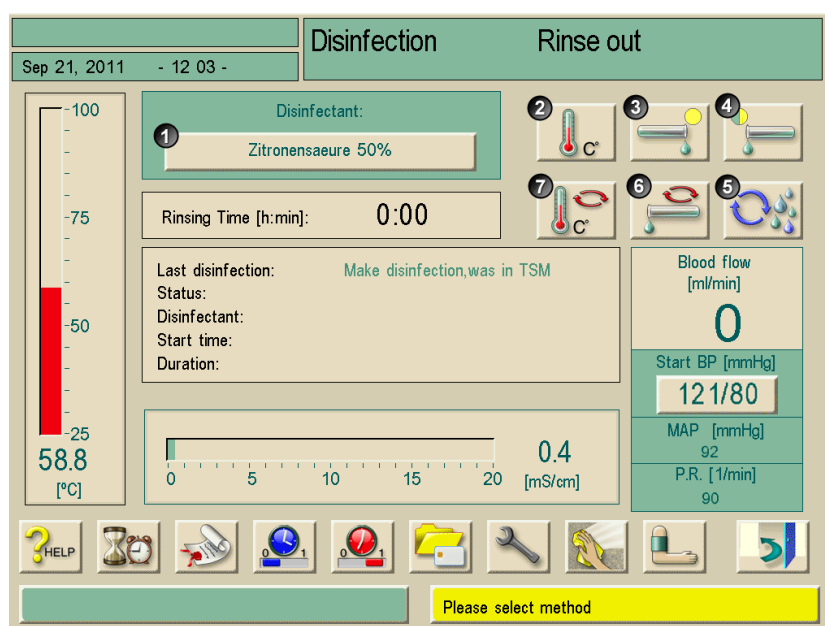

Fig. 11-1 Selection of Disinfection program



- Touch icon in Disinfection mode
A window will open.

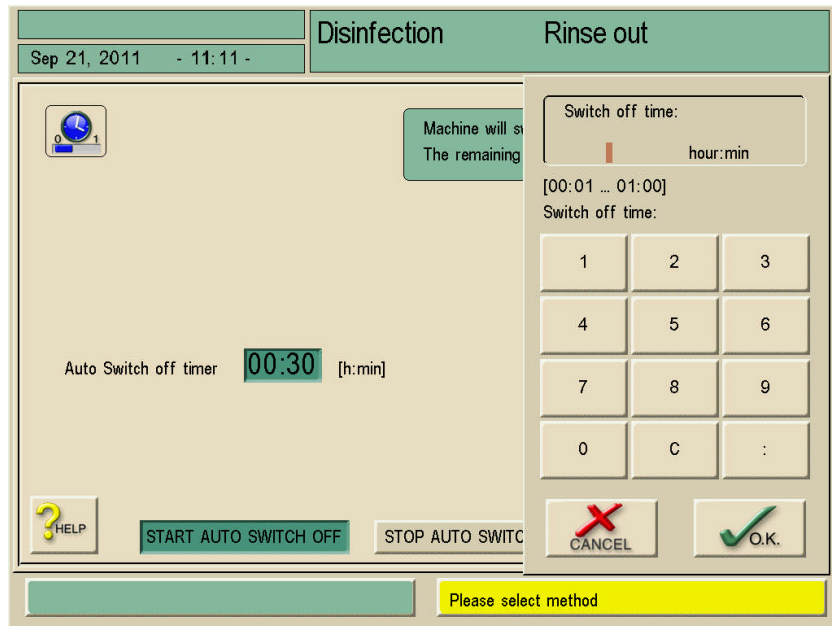

Fig. 11-2 "Auto Switch-Off" screen

- Set time by using the number buttons.
- Accept time by touching icon O.K.
- To start program, press the Start Auto switch off button.
- To change the time-out, enter anytime in Disinfection Selection or Disinfection.
- To stop the program, press the Stop Auto switch off button.



Leave mains switch of dialysis machine switched on.
Ensure that sufficient disinfectant is connected.

11.2 Weekly disinfection program

The weekly program “Weekly disinfection program” simplifies the configuration of the operations.



- Touch icon in Disinfection mode (see Fig. 11-1)
The following window opens:

Week day	Start Time	Method	Auto Switch off	
Monday	00:00	Thermic	YES	NO
Tuesday	01:00	Citric Acid 50 %	YES	NO
Wednesday	02:00	Thermic	YES	NO
Friday	00:00	None	YES	NO

Next disinfection: May 06, 2011 00:00

Fig. 11-3 Scheduled auto disinfection screen

Item	Text	Comment
1	Scheduled auto disinfections	The next programmed disinfection is indicated.
2	Week day	Any week day from Monday through Sunday can be entered. One day can also be entered several times, if more than one operation per day is required.
3	Start time	The start time of the operation can be entered.
4	Method	The following methods can be entered: <ul style="list-style-type: none"> - Rinsing - Thermal - Citric Acid 50% - Central Thermal - None

Item	Text	Comment
5	Switch-Off	Enter whether the machine should remain switched-on after the operation or should switch-off. Yes: The dialysis machine will be switched-off right after the entered method. No: The dialysis machine will remain switched-on right after the entered method.
6	-	Indicates rows to delete
7	Delete	Deletes all marked rows
8	New	New rows can be added to the table (21 in total).
9	Start Program	The weekly disinfection program is started with this button. It runs until (10) is pressed.
10	Stop Program	The weekly disinfection program is stopped with this button. It is stopped until (9) is pressed.
11	Cancel	Leave window without saving setting
	OK	Leave window with saving setting



Leave mains switch of dialysis machine switched on.
Ensure that sufficient disinfectant is connected.



The auto switch-off and the weekly disinfection program have to be activated in TSM.

11.3 Configuring the weekly disinfection program

The dialysis machine can be configured in such a way that it automatically switches on, carries out a disinfection and switches off again. The parameters of the automatic disinfection can be set for one week.



- Touch icon on disinfection screen.
The weekly disinfection program screen is displayed.

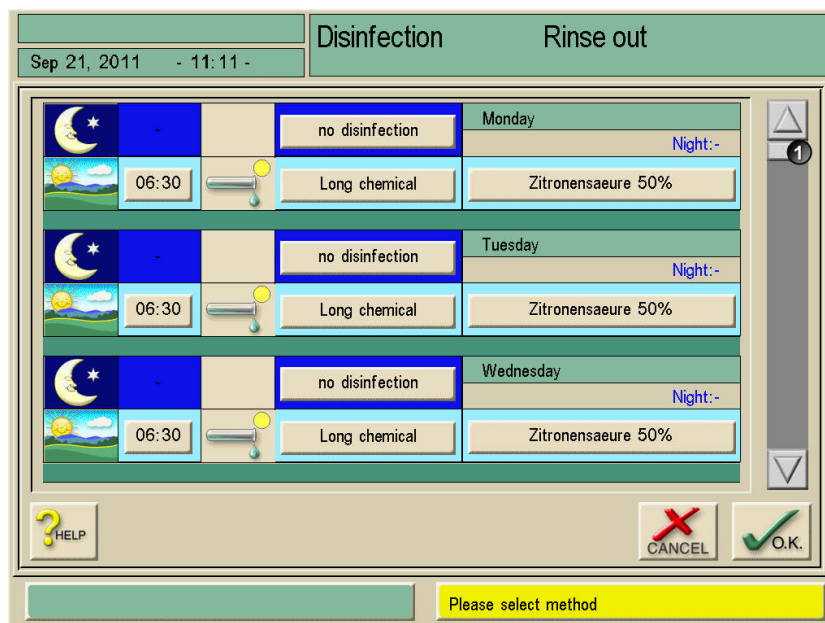

Fig. 11-4 Weekly disinfection program (Example)

Fig. 11-4 shows the set-up for the following disinfection modes:

Day/time	Description
Monday	
0.00 hrs.	A thermal, central disinfection is carried out. The machine switches on automatically and off again after disinfection.
6.30 hrs.	A chemical disinfection with citric acid 50% is carried out. The machine remains switched on after disinfection.
Tuesday	
0.00 hrs.	The unit is rinsed from the central water supply. The machine switches itself on automatically and off again after rinsing.
6.30 hrs.	A chemical disinfection with citric acid 50% is carried out.
Wednesday	
0:00 hrs.	No disinfection is carried out.
6.30 hrs.	A chemical disinfection with citric acid 50% is carried out. The machine remains switched on after disinfection.

- Use scroll bar 1 to move to other weekdays.
- Touch respective field and change settings.

The settings are automatically stored.

The following setting options are available:

- No disinfection
- Thermal disinfection
- Central thermal disinfection
- Central chemical disinfection
- Rinsing
- Long chemical disinfection (only daytime setting)
- Short chemical cleaning (only daytime setting)

The automatic start of the preparation of the dialysis machine in the morning must be activated in the service program.

i

With the setting "Day/rinsing", the dialysis machine changes to the "Preparation/test" mode after switch-on.

Upon completion of an automatic night action, the dialysis machine switches itself off again.

Upon completion of an automatic day action, the dialysis machine remains in "Rinse-out" mode.

11.4 Configuring profiles

11.4.1 Basic principles

Parameters are set as absolute or constant values or as profiles with a time-adjusted progress.

The following parameters are available for profiles:

- Dialysate flow
- Dialysate temperature
- Dialysate conductivity (overall)
- Ultrafiltration
- Heparin
- Bicarbonate conductivity

For ultrafiltration, a selection of twenty preprogrammed or one individual profile is available.

11.4.2 Setting profile parameters

The setting of the parameters is explained using the conductivity (Na) profile as an example.

Legend

- 1 Profile settings
- 2 Enter therapy parameters
- 3 Heparinization data
- 4 Pressure limits
- 5 Ultrafiltration data
- 6 Dialysate parameters

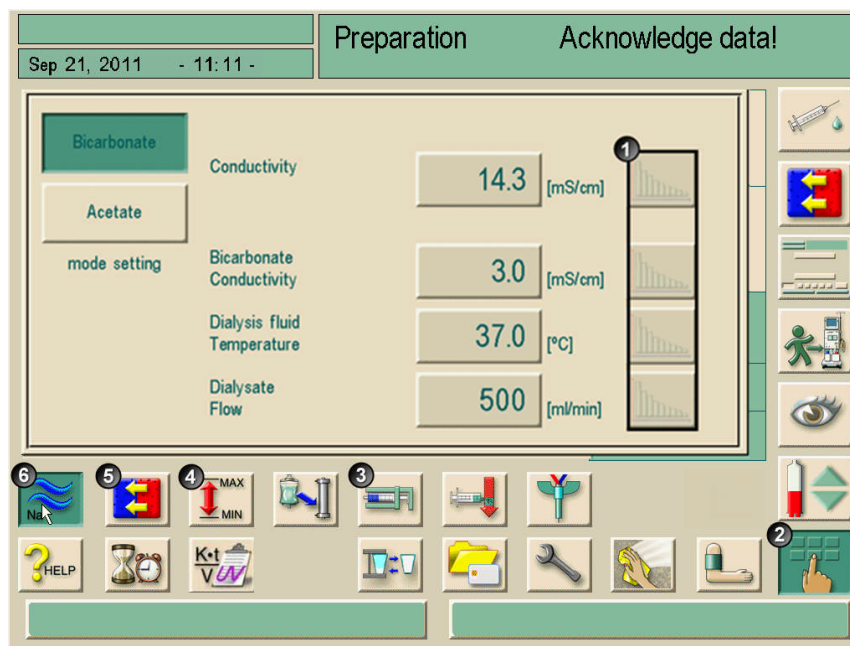

Fig. 11-5 "Conductivity" screen

- Touch icon 2
- Touch icon 6
- Touch icon 1

The following screen appears:

Legend

- 1 Linear profile
- 2 Exponential profile
- 3 Parameter bar
- 4 Duration of parameter bar
- 5 Therapy time setting
- 6 Manual input of the total value = resetting the profile to horizontal shape
- 7 Value for the selected parameter bar

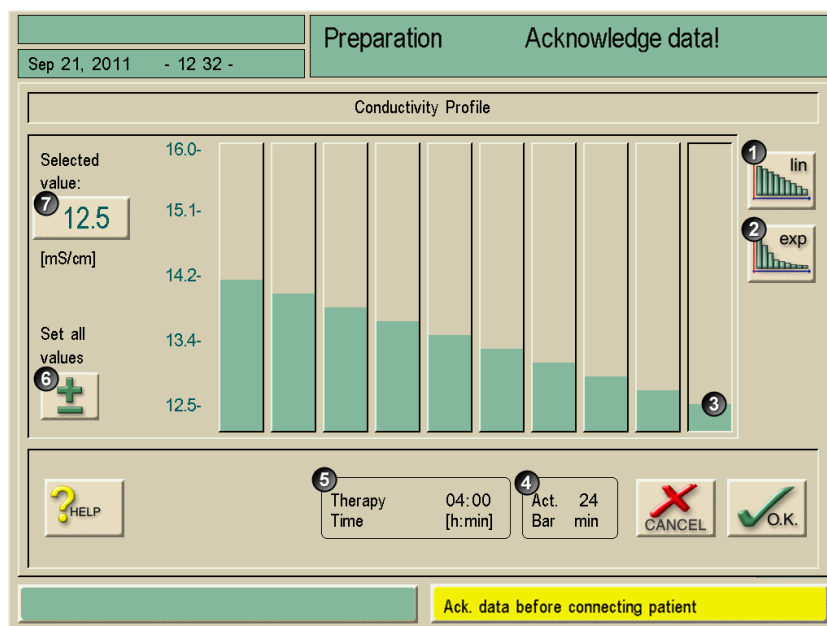

Fig. 11-6 "Profile parameters" screen

The "profile parameters" screen contains a graphic with ten parameter bars, representing the treatment time. In other words, based on a 4 hour (240 minutes) therapy time, one parameter bar covers 24 minutes.

Four options for adjusting the parameters are available.

Option 1: Manual adjustment of values

- Adjust values by moving each parameter bar 3 on the touch screen, using your finger (imprecise).

Option 2: Direct entry

- Touch the parameter bar to be adjusted.
- Touch icon 7.
- Enter value directly via the keypad or through icons +/-.
- Accept value by touching icon O.K.

Option 3: Automatic (linear/exponential) distribution

- Select first parameter bar.
- Touch icon 7.
- Enter value via keypad and confirm with icon O.K.
- Select last parameter bar.
- Touch icon 7.
- Enter value via keypad and confirm with icon O.K.

Option 4: Create a developing profile by moving the finger over the diagram.

- Position the finger at the first or last bar.
- Move the finger over all bars along the desired developing profile.

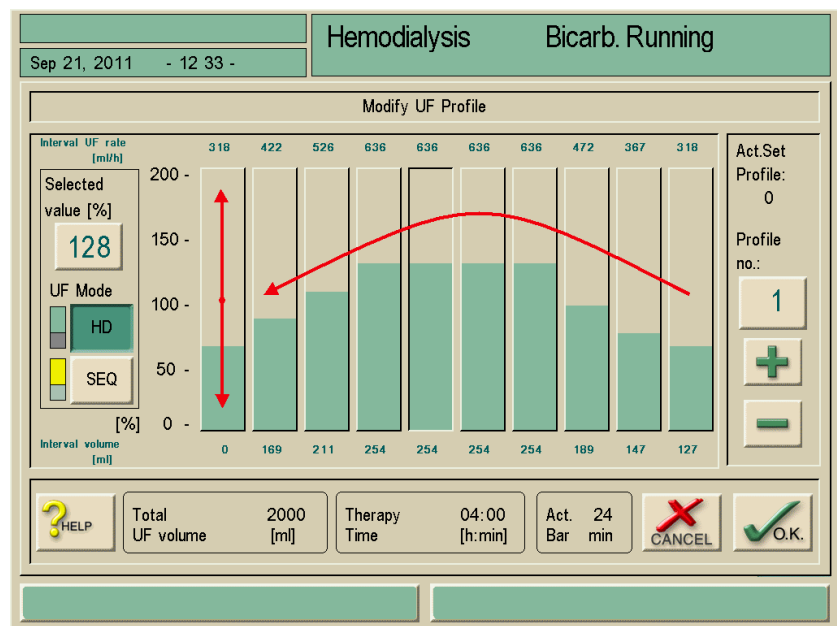

Fig. 11-7 Edit profile

11.5 UF profiles

11.5.1 Selecting UF profiles

Apart from the individual settings, the dialysis machine offers standardized ultrafiltration profiles. As another option, an individual UF profile can be preselected at any time and stored on the patient's disk/therapy chip card. The profile table contains descriptions of the different profiles.



- Touch icon.
The "UF parameters" screen appears.

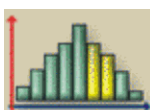

- Touch icon.
The "UF profile" screen appears.
The UF rate setting is specified above each parameter bar.

Legend

- 1 Profile number
- 2 Next profile number
- 3 Previous profile number
- 4 UF without dialysate flow (sequential therapy)
- 5 UF with dialysate

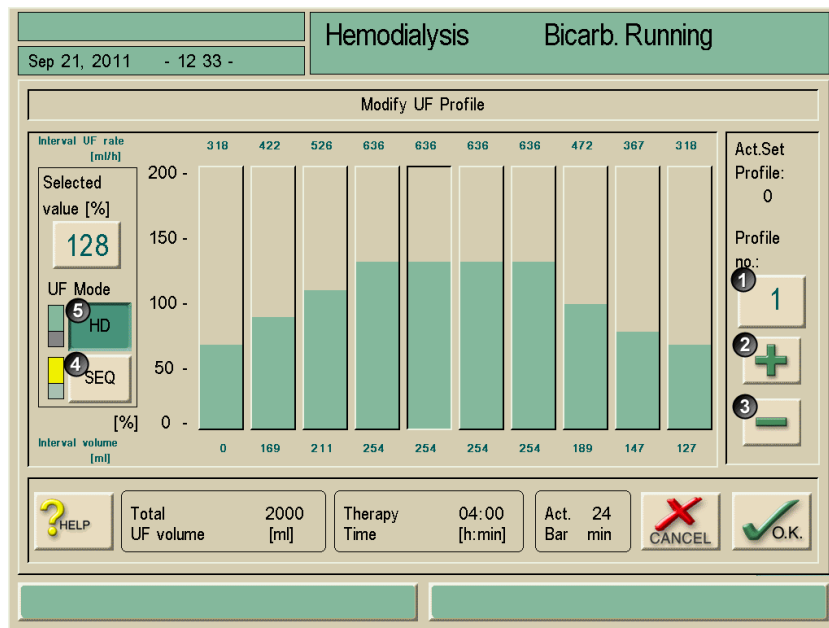

Fig. 11-8 "UF profile" screen

- Touch icon 2 or 3 to select other UF profiles. Apart from the even ultrafiltration profile (profile 0), nineteen other UF profiles are available.
- Touch icon 4 or 5 to change from "Dialysate flow (HD)" mode to sequential therapy (SEQ).



Sequential therapy is ultrafiltration without dialysate flow. A sequential phase in an UF-profile is highlighted in yellow, e.g. profile no. 4 and 6.



Risk of dehydration!

- A sequential therapy for a period of over 2 hours may only be set up on the instruction of a doctor.



Risk of hyperpotassemia/hypercalcaemia!

- Carrying out a whole therapy in "sequential" mode may lead to increased blood values of the patient.
- A sequential therapy for a period of over 2 hours may only be set up on the instruction of a doctor.



Risk of cardiovascular instability through high UF exposure!

- Special consideration should be made to the patient when selecting a UF profile.
- The responsible physician should be informed.



During automatic calculation, the last bar is adjusted depending on the total value.

11.5.2 UF profile table

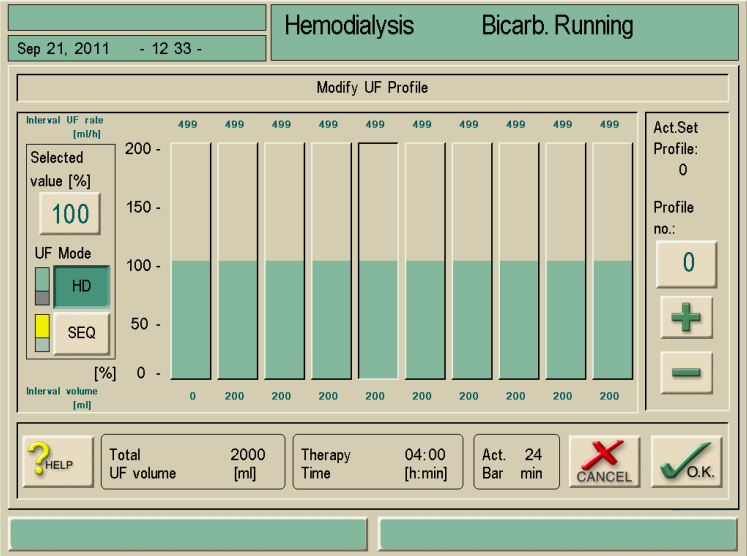
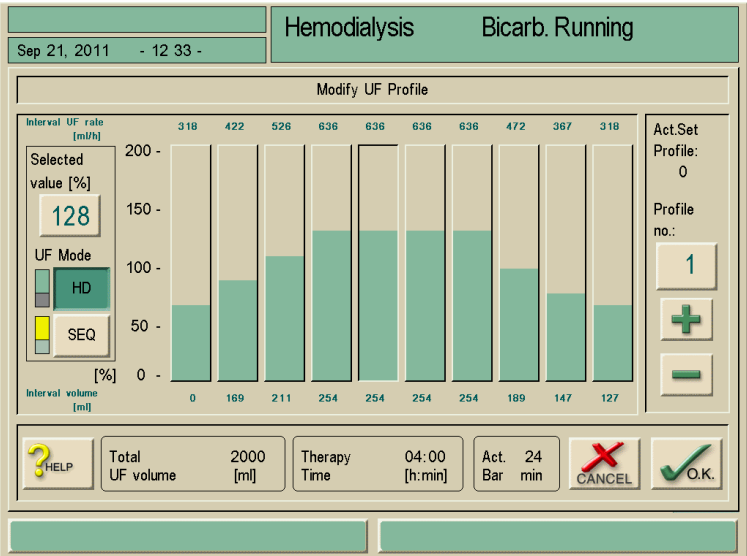
Profile no.	Description
0	<p>Standard profile Constant UF rate over entire therapy time.</p> 
1	<p>Particularly gentle therapy start and end phases, due to stepped UF rate increase/reduction.</p> 

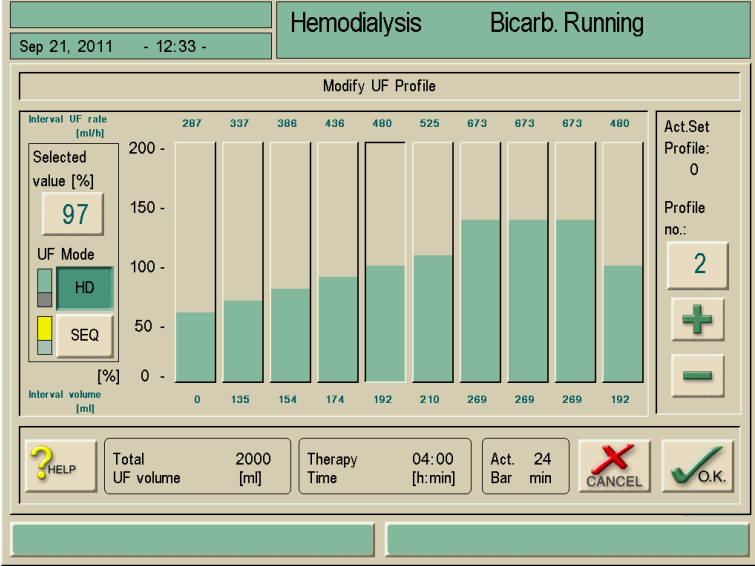
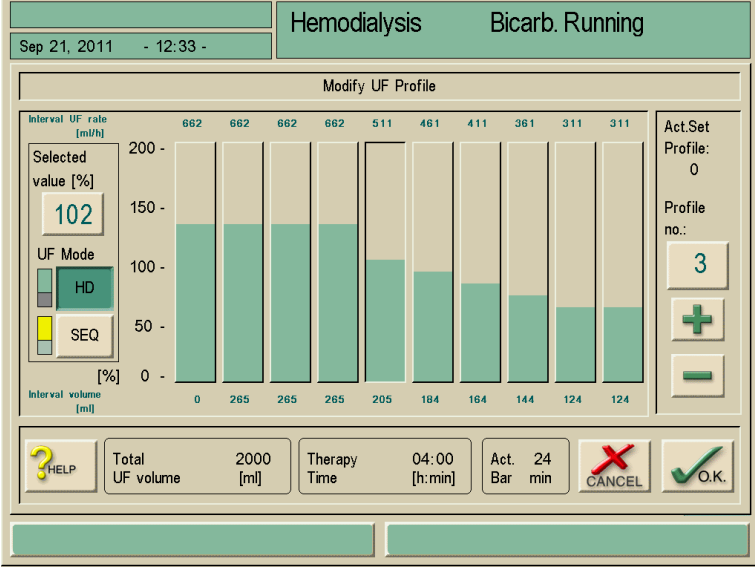
Profile no.	Description
2	<p>Particularly gentle therapy start due to stepped UF rate increase.</p>  <p>The screenshot shows the 'Modify UF Profile' dialog for Profile 2. The top bar indicates 'Hemodialysis Bicarb. Running' and the date/time 'Sep 21, 2011 - 12:33 -'. The main area features a bar chart with 10 intervals. The y-axis represents 'Interval UF rate [m/h]' from 0 to 200, and the x-axis represents 'Interval volume [ml]'. The UF rate values for the intervals are 287, 337, 386, 436, 480, 525, 673, 673, 673, and 480. The selected value is 97%. The UF mode is set to HD. The total UF volume is 2000 ml, therapy time is 04:00, and act. bar is 24 min. The profile number is 2. The dialog includes a HELP button, a CANCEL button, and an O.K. button.</p>
3	<p>Particularly gentle therapy end due to stepped UF rate decrease.</p>  <p>The screenshot shows the 'Modify UF Profile' dialog for Profile 3. The top bar indicates 'Hemodialysis Bicarb. Running' and the date/time 'Sep 21, 2011 - 12:33 -'. The main area features a bar chart with 10 intervals. The y-axis represents 'Interval UF rate [m/h]' from 0 to 200, and the x-axis represents 'Interval volume [ml]'. The UF rate values for the intervals are 662, 662, 662, 662, 511, 461, 411, 361, 311, and 311. The selected value is 102%. The UF mode is set to HD. The total UF volume is 2000 ml, therapy time is 04:00, and act. bar is 24 min. The profile number is 3. The dialog includes a HELP button, a CANCEL button, and an O.K. button.</p>

11

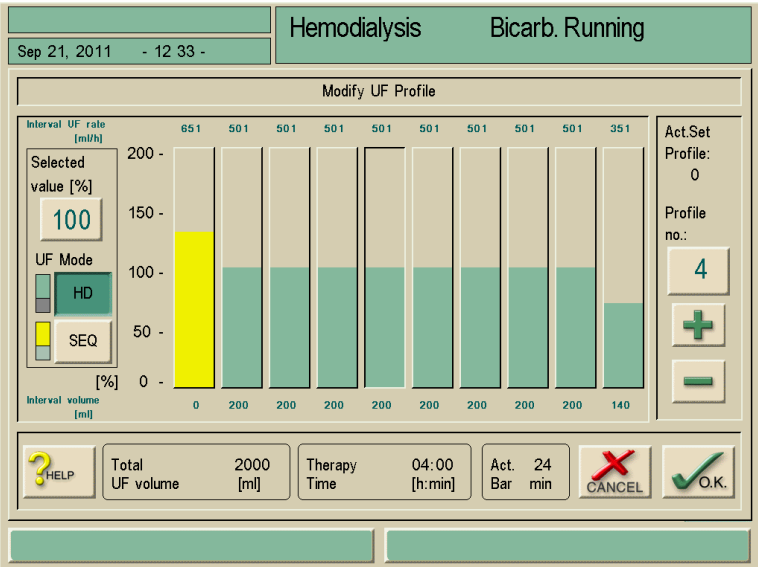
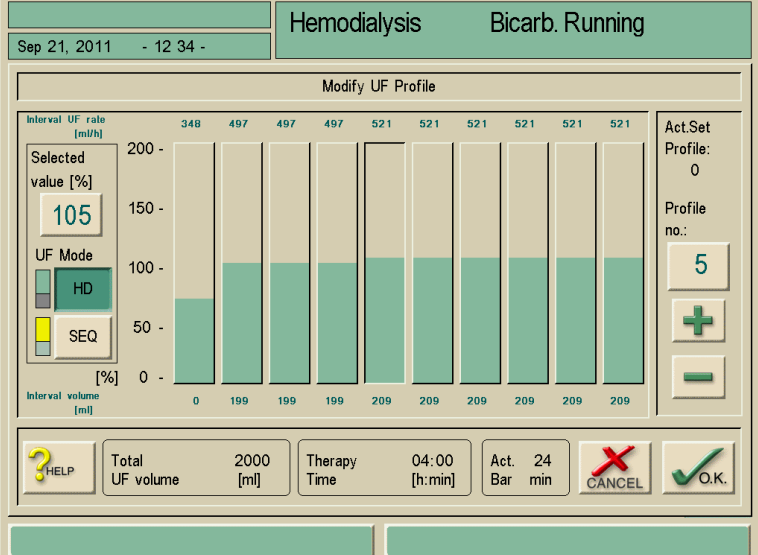
Profile no.	Description
4	<p>In the first section, the sequential operating mode is set automatically. This profile is suitable for patients who require greater fluid removal at the beginning of their treatment.</p> 
5	<p>Particularly suited for starting up parallel flow dialyzers.</p> 

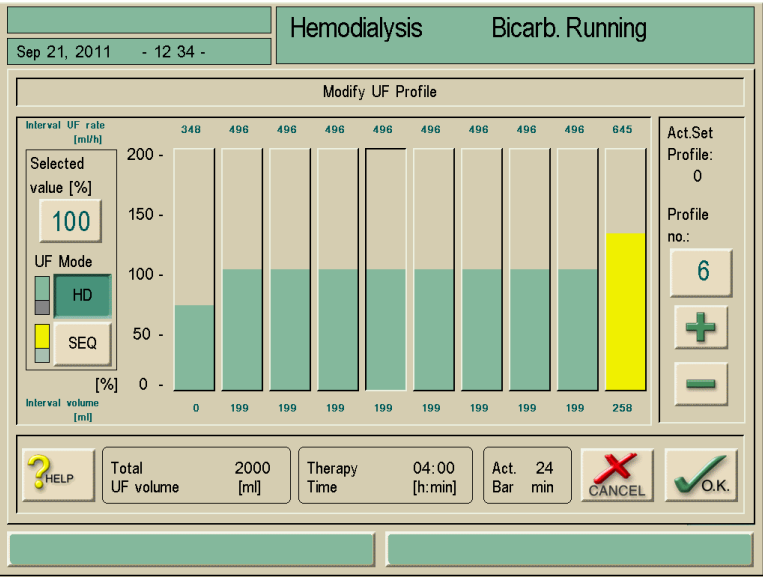
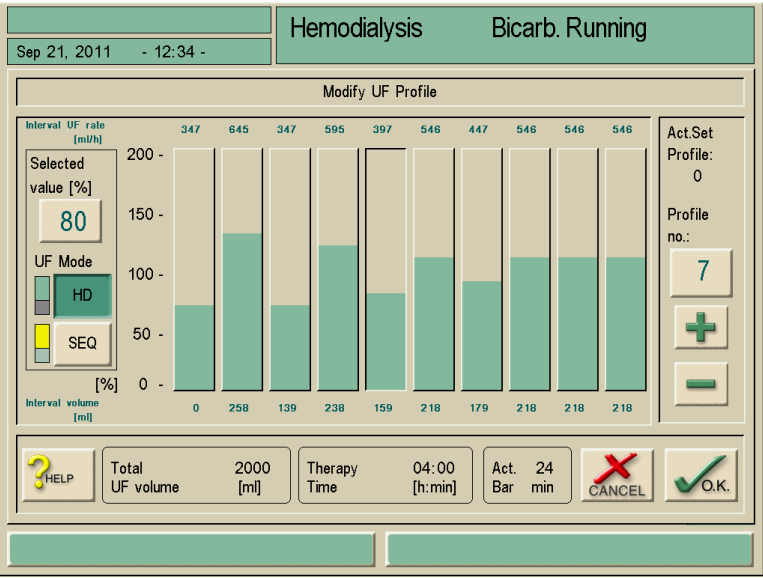
Profile no.	Description
6	<p>The sequential operating mode is automatically set in the last section. This profile is suitable for patients who require greater fluid removal at the beginning of their treatment.</p> 
7	<p>Alternating high and low phases during the initial treatment period, with constant fluid removal at the end of the treatment.</p> 

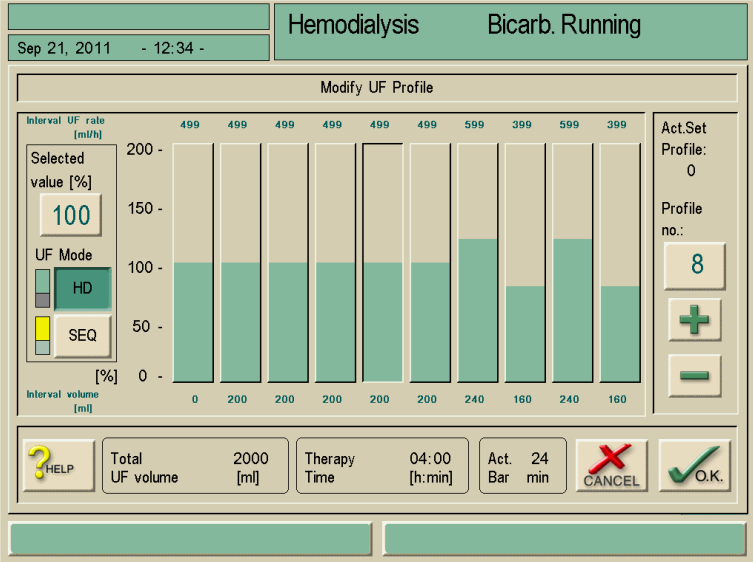
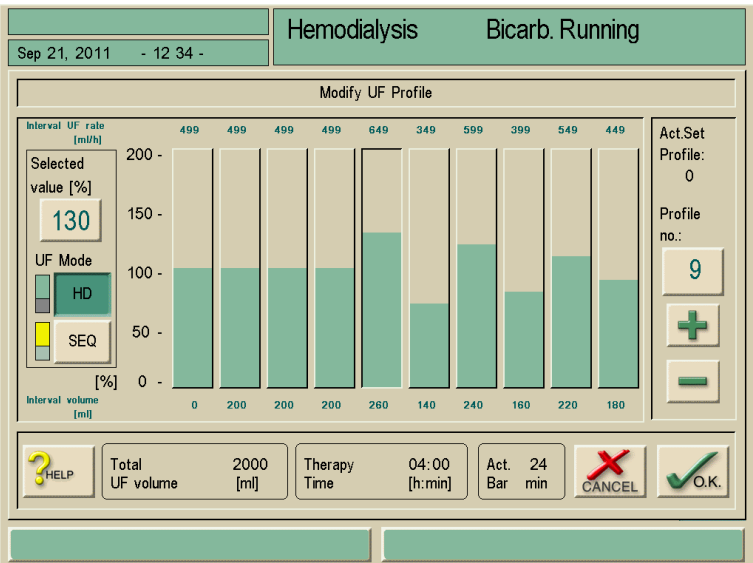
Profile no.	Description
8	<p>Alternating high and low phases at the end of the dialysis.</p> 
9	<p>Alternating high and low phases during the second treatment period, with constant fluid removal at the beginning of the treatment.</p> 
10	<p>Freely settable. When a given profile is changed, the machine assigns a name to it and stores it as profile 10. When the profile is changed again, the previous profile is overwritten.</p>
11-30	<p>Profiles no. 11 to 30 can be preset by the technical service according to customer requirements.</p>

11.6 Patient therapy chip card



The Card reader can be installed as an option on Dialog+ machines.

The patient therapy card offers the option of individually storing nearly all pre-settings for a therapy and calling them up again at the preparation stage. Also, treatment results from up to 50 therapies can be stored after a therapy.



The patient therapy card should be ordered from B. Braun Medical Inc. to have a certified quality standard.

11.6.1 Erasing data from patient therapy card



- Touch icon.
The selection menu appears.
- Insert therapy card into drive.



- Touch icon.
All data on the patient therapy card will be erased!

11.6.2 Entering the patient name

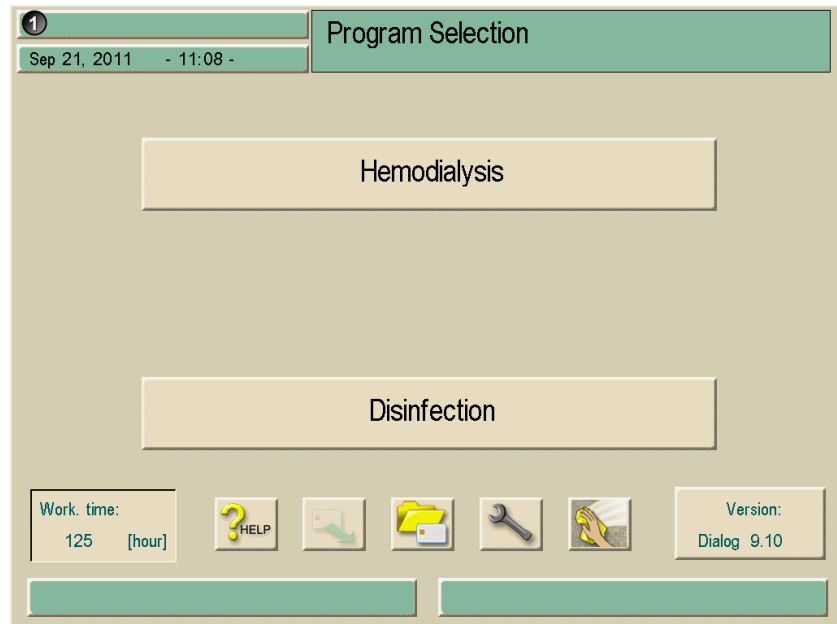

Fig. 11-9 Recording the patient name

The patient name can be entered in field 1 of the input screen.

➤ Touch field 1.

The keyboard appears on the screen.

Legend

- 1 Entry field
- 2 Delete all characters to the left of the cursor
- 3 Delete all characters
- 4 Delete all characters to the right of the cursor
- 5 Insertion mode
- 6 Shift key
- 7 Special characters on
- 8 Special characters off

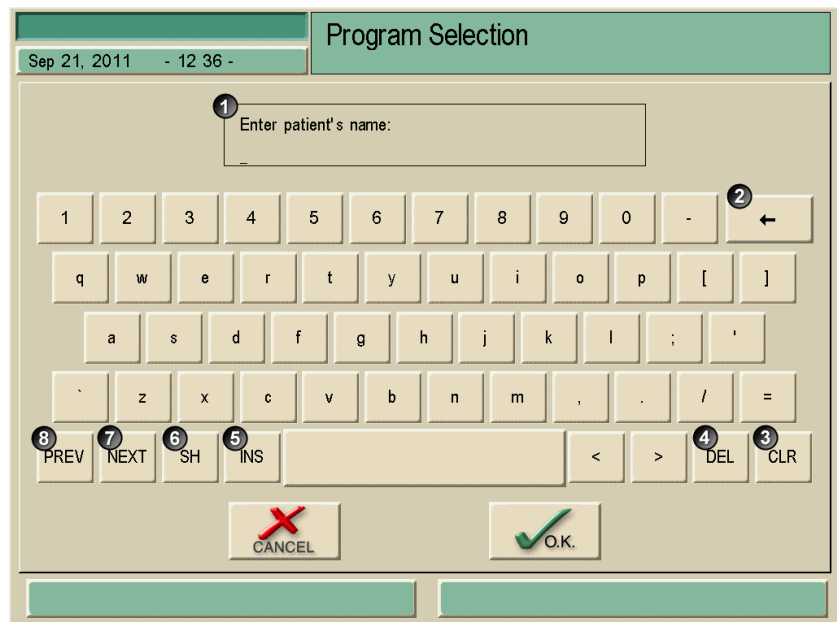

Fig. 11-10 Patient name keyboard

➤ Enter patient name in field 1, using the keyboard, and confirm with icon O.K.



When working with the therapy chip card, an additional field, "Patient number" is displayed in the "Patient Overview" screen. This helps to differentiate between patients with the same name.

11.6.3 Reading patient data

Patient data can only be read in the Program Selection and Preparation modes.



- Insert therapy chip card into card reader.
- Touch icon.
The read-in operation is displayed on the screen.



- Check data in overview. Change to second page, where applicable.
If the therapy chip card contains data that, for technical reasons, cannot be read by the dialysis machine, this red icon appears.
- Touch icon and confirm modification mask for the respective parameter with O.K.
The icon disappears once all faulty parameters have been changed.

Patient data can only be transferred from the therapy chip card if there is no data left on the screen highlighted by a red background.

- Accept all parameters by touching the O.K. icon appearing in the bottom right corner.

By inserting the therapy card in Program Selection or Preparation, data is read automatically.

11.6.4 Storing patient data (parameter settings)



- Touch icon after changing the parameter settings.
The patient data is stored on therapy chip card.
- Save effectiveness data (Kt/V), see next section.



Machines operated with option Nexadia have other saving options. These are described in the respective Instructions for Use.

11.7 Theoretical Kt/V calculation



- Ensure that patient therapy chip card has been inserted into the dialysis machine.
- Touch icon.

A screen for entering the patient data for the calculation of the theoretical effectiveness e.g. Kt/V, is opened.

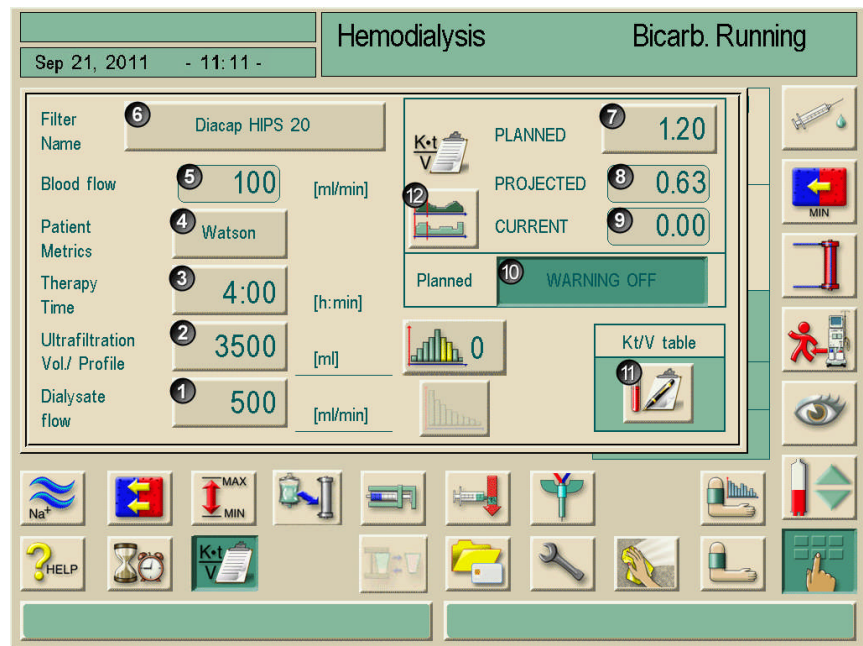

Fig. 11-11 Input window for calculating the effectiveness (Kt/V values)

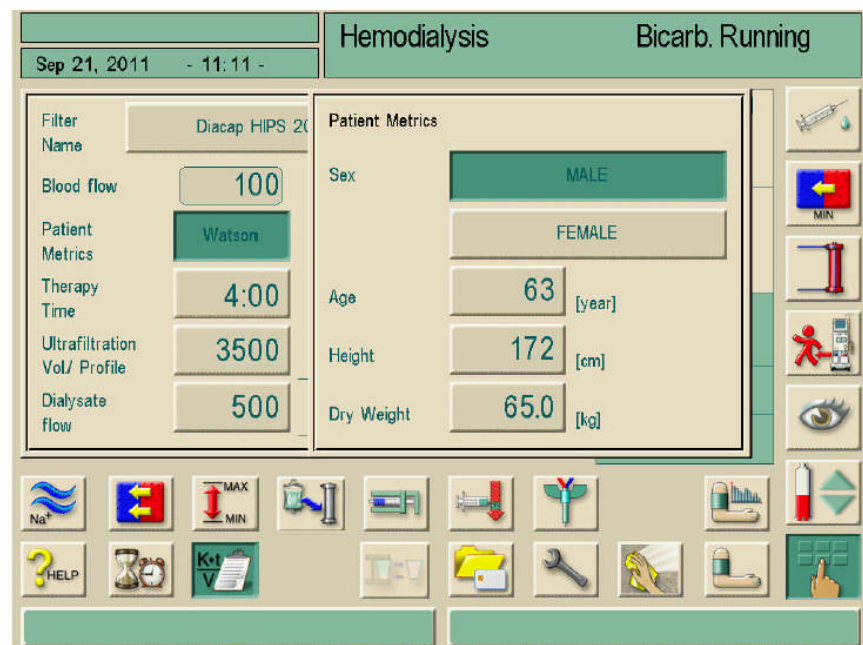

Fig. 11-12 Input window patient data after touching "Watson" icon

Item	Text	Comment
1	Dialysate flow	Entry and display of dialysate flow in mL/min
2	Ultrafiltration Volume/Profile	Entry and display of ultrafiltration volume in mL and profile of ultrafiltration
3	Therapy Time	Entry and display of dialysis duration in hours and minutes
4	Patient data	Entry of: <ul style="list-style-type: none"> • Sex • Age • Size • Dry weight for identification of urea distribution volume using the "Watson" formula.
5	Blood flow	Display of the measured value during dialysis
6	Filter Name	Input and display of dialyzer in use. The data must be stored in a table in the service program.
7	PLANNED	Entry of intended Kt/V value
8	PROJECTED	Computed probable Kt/V value at the end of the dialysis, calculated with the actual blood flow
9	CURRENT	Current Kt/V value determined by the dialysis machine
10	WARNING OFF	If the intended Kt/V value (target value) will probably not be achieved, the dialysis machine automatically displays a warning. To switch off the warning function, activate field "Warning off".
11	Kt/V table	Opens a screen with the table of the patient's Kt/V values from the patient therapy chip card
12	Kt/V graphics	Opens a graphical display of the planned and actual Kt/V progression

➤ Change the following parameters, if necessary:

- Filter Name (6)
- Patient data (4)
- Therapy Time in hours and minutes (3)
- Ultrafiltration: Vol./Profile in mL (2)
- Dialysate flow in mL/min (1)
- Planned (7)

Show table

➤ Touch icon (11).

The Kt/V results are transferred from the therapy chip card and shown in a screen:



Test Patient 1		Hemodialysis		Bicarb. Running				
Sep 21, 2011 - 11:11 -								
Date of Therapy [d-m-y]	Therapy Time [h:min]	Patient Dry W. [kg]	UF Vol. [ml]	Blood Vol. [l]	C.T. Blood [%]	Treatm. Kt/V	Urea Kt/V	Dial/ Urea Kt/V[%]
02-03-10	00:06	65.0	89	0.8	98.1	0.02
01-03-10	00:05	65.0	74	0.7	97.9	0.02
26-02-10	00:04	65.0	69	0.6	98.1	0.02
25-02-10	00:09	65.0	140	1.5	97.1	0.04
15-01-10	00:00	0.0	0	0.0	0.0
02-09-09	00:07	0.0	106	1.6	94.7
19-01-09	00:00	80.0	13	0.1	94.9
03-11-08	00:07	0.0	106	1.6	94.3

Buttons: ? HELP, CANCEL, O.K.

Fig. 11-13 "Table Kt/V values" screen

Entering laboratory results

Because laboratory results before and after dialysis are not available at this point, entering these values into the table may be done retrospectively.

- Touch appropriate line.

A screen for entering the laboratory results appears:

Test Patient 1		Hemodialysis		Bicarb. Running				
Sep 21, 2011 - 11:11 -								
Date of Therapy [d-m-y]	Therapy Time [h:min]	Patient Dry W. [kg]	UF Vol. [ml]	Blood Vol. [l]	C.T. Blood [%]	Treatm. Kt/V	Urea Kt/V	Dial/ Urea Kt/V[%]
02-03-10	00:06	65.0	89	0.8	98.1	0.02
Patient Dry weight		① 65.0 [kg]	Urea pre-therapy		② 0.0 [mmol/l]			
Clean/total Blood volume		98.1 [%]	Urea post-therapy		③ 0.0 [mmol/l]			
Therapy Kt/V		0.02	Urea conc. Kt/V		...			

Buttons: ? HELP, O.K.

Fig. 11-14 Entering laboratory results

- Enter the following laboratory results:
 - Dry weight of patient in kg (1)
 - Laboratory result for urea concentration prior to dialysis (mmol/l) (2)
 - Laboratory result for urea concentration after dialysis (mmol/l) (3)



➤ Touch icon.

The table with the current Kt/V figures is displayed. Changed figures are automatically saved to the patient therapy chip card.

Show graphics

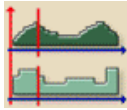

➤ Touch icon

A graphical display of the projected and actual Kt/V progression is shown.

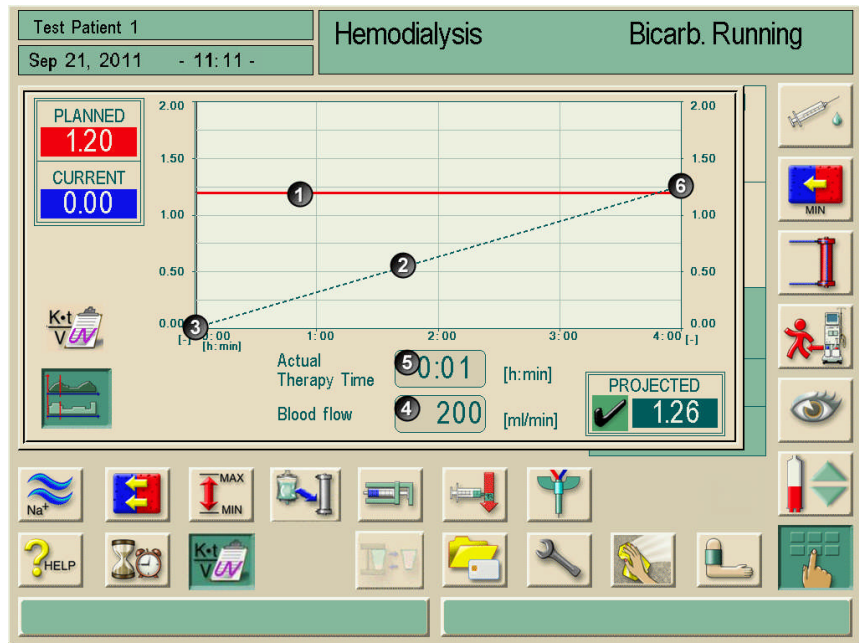

Fig. 11-15 Graphical display of Kt/V progression (Projected O.K.)

Item	Text	Comment
1	Aim Kt/V	Planned Kt/V aim
2	Projected Kt/V progression	Graphical display of the projected Kt/V progression
3	Current Kt/V progression	Display of actual and current Kt/V progression
4	Actual blood flow	Display of present Therapy time
5	Actual therapy time	Display of the momentary blood flow
6	Projected Kt/V aim	Display of projected Kt/V result (O.K., aim Kt/V will be reached, has been reached)
7	Projected Kt/V aim	Display of projected Kt/V result (not O.K., aim Kt/V won't be reached, hasn't been reached)
8	Cursor line	Cursor line shows the current therapy moment

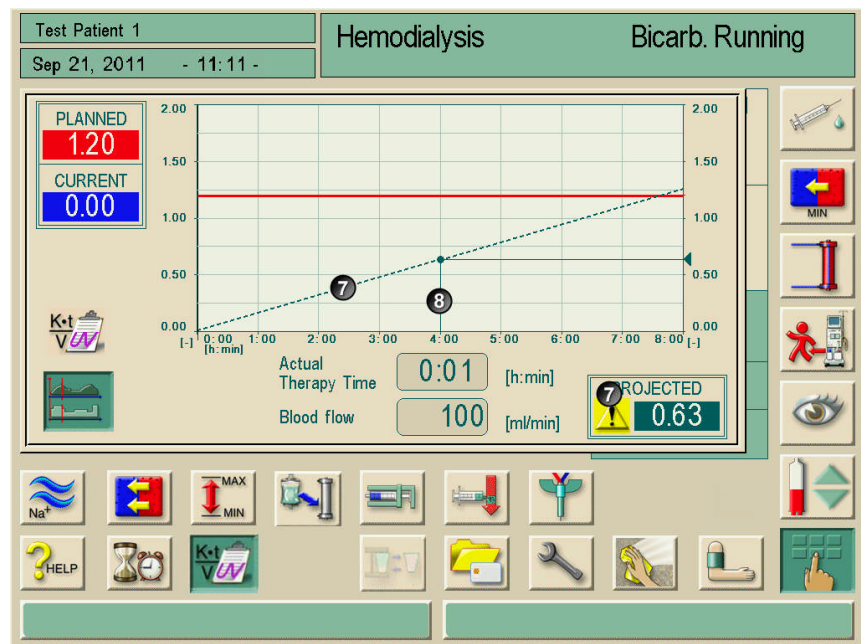

Fig. 11-16 Graphical display of Kt/V progression (Projected not O.K.)

i

Kt/V will be not calculated in the therapy mode "Seq." and "HF".

i

To arrange a correct blood withdrawal according to quality guidelines for a Kt/V calculation, the Dialog+ changes after the treatment on an UF rate of 50 mL/h.

The blood pump runs on with the selected speed.

A monitoring of the duration of this mode can be carried out by the use of the timer function.

End Kt/V

- Touch icon on the "Table Kt/V value" screen.



The screen is closed. All entered data are stored on the patient therapy chip card. When closing the screen by touching the icon **CANCEL**, no data is stored.

11.8 Adjusting monitor brightness

Monitor brightness can be adjusted in the following way:

- Manually, continuously
- Manual switch between preset day/night brightness.
- This must be activated in the service program.

Procedure



- Touch icon.
The data management screen appears.



- Touch icon.
The screen for adjusting the brightness is displayed.
To set the brightness manually:
 - Adjust brightness using the slide displayed on the screen.
"Manual" is displayed at the center of the screen.
 To set the brightness for daytime:
 - Activate field **Daytime settings**.
"Daytime" is displayed at the center of the screen.
 To set the brightness for nighttime:
 - Activate the field **Nighttime settings**.
"Nighttime" is displayed at the center of the screen.

Screensaver

- To activate the screensaver:
- Touch the field **Yes** next to the field **Screensaver on**.
- To deactivate the screensaver:
- Touch field **No**.
 - To close the screen, touch the "Brightness adjustment" icon.



It is recommended to activate the screen saver.



- To close the screen, touch the "Data management" icon.
If **Screensaver on** has been activated with **Yes**, the screensaver will be activated after the time preset in the service program.
The screensaver shows 3 moving objects against a dark background:
 - Pie chart of therapy time
 - Mode
 - Time
 If option ABPM is installed, last BP results are shown instead of time
Alarms or touching the screen switch off the screensaver and the active screen appears again.

11.9 Selecting language of screen text

Depending on the languages available in the TSM, you can choose the language for the screen text.

Procedure



- Touch icon
The data management screen appears.



- Touch icon
The screen with all available languages appears.



Fig. 11-17 Screen "Available languages"

- Touch row with selected language
- Touch button for changing the language.
Screen text appears in chosen language.

11.10 Editing trend group parameters

You can edit the combination of parameters within the trend group.

Procedure

- Call screen "Overview trend groups" as described in chapter 6.3.5.

Legend

- 1 Field trend group
- 2 Button "edit group"
- 3 Choose TSM presettings
- 4 Leave screen and save changes
- 5 Leave screen without saving

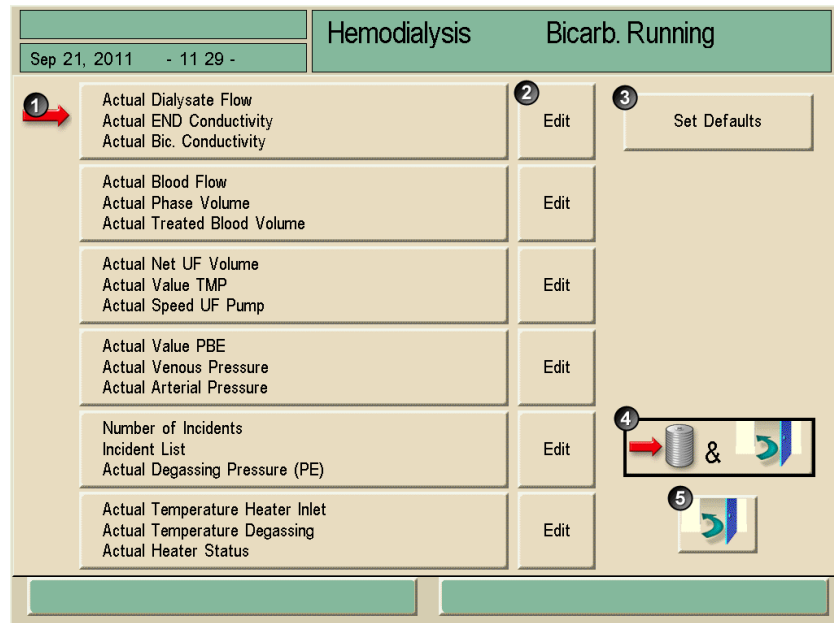

Fig. 11-18 Screen "Overview trend groups"

Single groups could be edited individually with parameters of your own choice.

- Touch favored button.
The following screen appears.



Legend

- 1 Field "trend group parameters"
- 2 Field "list of parameters"
- 3 Scroll bar "trend groups"
- 4 Scroll bar "list of parameters 2"
- 5 Leave screen

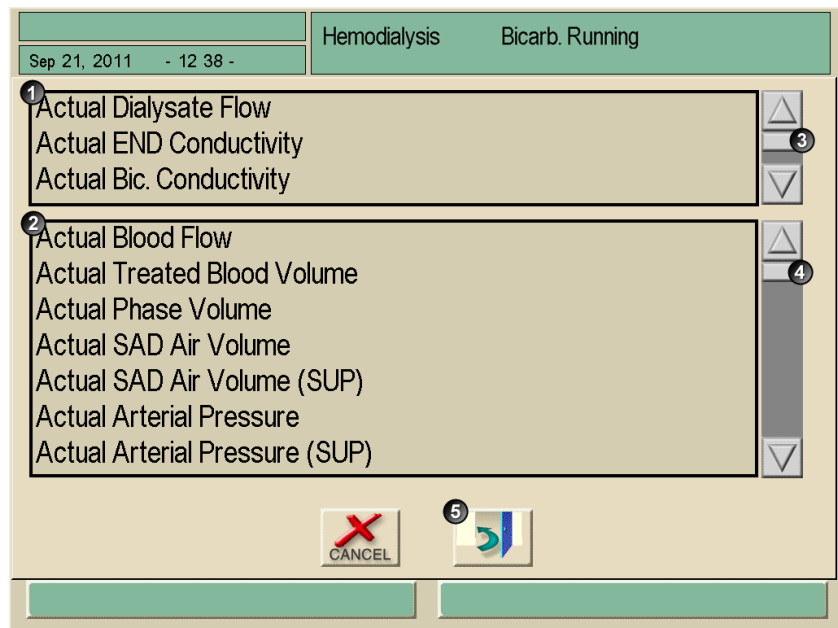

Fig. 11-19 Edit trend groups

- Touch parameter to replace in field 1. Parameter will be marked by a frame.
- Search desired parameter in list 2 and touch. The marked parameter will be replaced.
- Choose next parameter and replace as described.



- Touch icon to leave the screen. The screen "overview trend groups" appears.



- Touch icon to save the new trend group. In the TSM preset trend groups could be set up again.



- Touch icon.

Table of contents

12	Maintenance and cleaning	12-3
12.1	External cleaning.....	12-3
12.2	Preventive maintenance and technical safety inspection.....	12-4
12.2.1	Regular preventive maintenance.....	12-4
12.2.2	Technical safety inspection	12-5
12.2.3	Accessories, disposable items and expendable parts.....	12-5
12.3	Technical service and warranty	12-5
12.3.1	Warranty.....	12-5
12.4	Disposal of old dialysis machines.....	12-5

12 Maintenance and cleaning

12.1 External cleaning



Electric shock and fire hazard!

- Ensure that no fluid enters the machine.
- Ensure that no fluid is on the mains plug or on the mains socket.



Risk of cross-infection because of contamination!

- It is recommended that the outer surface of the machine be cleaned after each therapy using an appropriate disinfectant.
- In case of surface contamination with blood, disinfect and clean properly.
- In case of contamination of pressure connectors with blood, disinfect and clean properly.



Damage of surface by unknown ingredients!

B. Braun Medical Inc. does not assume liability for the integrity of the device when cleaned or disinfected using agents with unknown ingredients.

- Clean housing parts, monitor, inside and outside of the rinse bucket with ethanol (max. 70 %), isopropanol (60 % to 70 %) based cleaning agents, or 1:100 bleach solution (5:25 sodium hypochlorite) as per clinic policy and procedure.
- Use cleaning and disinfection agents only in accordance with the respective Instructions for Use. Ensure that the disinfectant/cleaning agent will be wiped off from the screen completely.

Wiping the monitor during operation



Touch icon.

The touch screen will be deactivated for 10 seconds and can now be cleaned.



Do not leave wet cleaning/disinfecting agents on the monitor. If necessary, dry with smooth cloth afterwards.

Blood pump roller



Do not put the blood pump rollers into a disinfectant bath, or the return safety device may be destroyed.

12.2 Preventive maintenance and technical safety inspection

12.2.1 Regular preventive maintenance

A regular preventive maintenance (service) is recommended **every 12 months** according to the specified check list in the service manual and with reference to the Instructions for Use. The preventive maintenance includes the replacement of wear and tear parts to ensure the fault-free operation of the dialysis machine.

This regular preventive maintenance (service) may only be carried out by trained personnel.

Depending on the setting in TSM, another maintenance interval can be set (see service manual chapter 5). If $\leq 5\%$ of the set time remains the following window (Fig. 12-1) appears once at the change from End of Therapy to Disinfection.

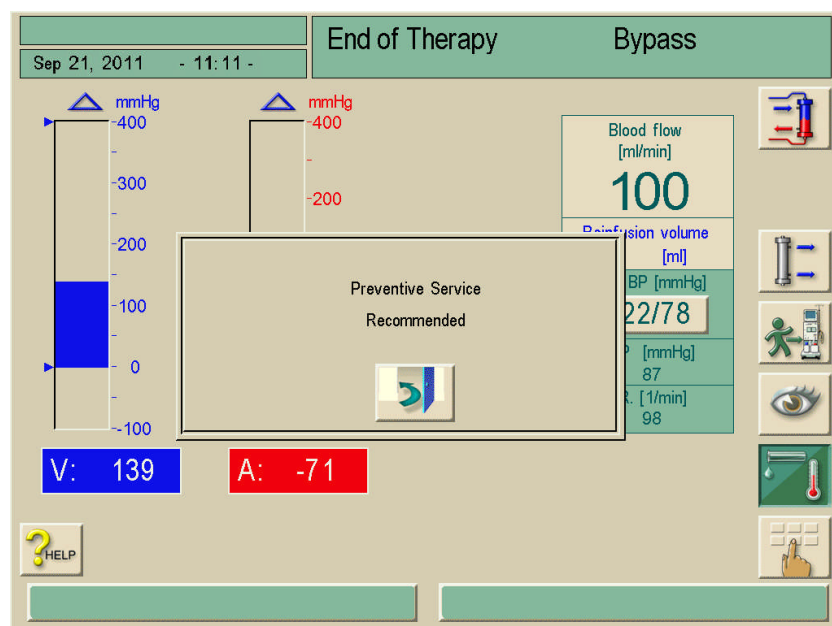

Fig. 12-1 Preventive Service recommended

If the adjusted maintenance interval is reached, the above window appears at every change to disinfection mode.

Service manual and technical training

A full service manual is provided only in connection with technical training.

12.2.2 Technical safety inspection

The technical safety inspection shall be performed and documented every 12 months, according to the specified check list in the service manual and with reference to the Instructions for Use.

- The dialysis machine should be checked by persons who have been appropriately trained or have the required expertise and/or experience and do not require instructions for the check.
- The technical safety inspection must be kept by the responsible organization (user) as part of their documentation.

12.2.3 Accessories, disposable items and expendable parts

Only accessories, disposable items and spare parts that do not pose a technical safety risk and demonstrably comply with Medical Devices Directive 93/42/EEC (MDD) may be used.

To ensure the full functionality of the dialysis machine, we recommend using products manufactured by B. Braun Medical Inc.

12.3 Technical service and warranty

12.3.1 Warranty

B. Braun Medical Inc. offers the warranty attached to the Appendix (chapter 16.3).

12.4 Disposal of old dialysis machines



Disinfect the dialysis machine appropriately before disposal!
For further information see chapter 1.7.

Table of contents

13	Alarms and remedial action.....	13-3
13.1	Displaying and resetting alarms.....	13-3
13.2	Alarms and consequences.....	13-5
13.3	Remedying SAD alarms when using standard A/V tubing systems	13-39
13.4	Manual blood return	13-41
13.5	Muting acoustic signals.....	13-43
	13.5.1 Muting acoustic signals for alarms	13-43
	13.5.2 Muting acoustic signals for messages	13-43

13 Alarms and remedial action

13.1 Displaying and resetting alarms

Legend

- 1 Comment field
- 2 Information field
- 3 Alarm field
- 4 Alarm list
- 5 Call up comments

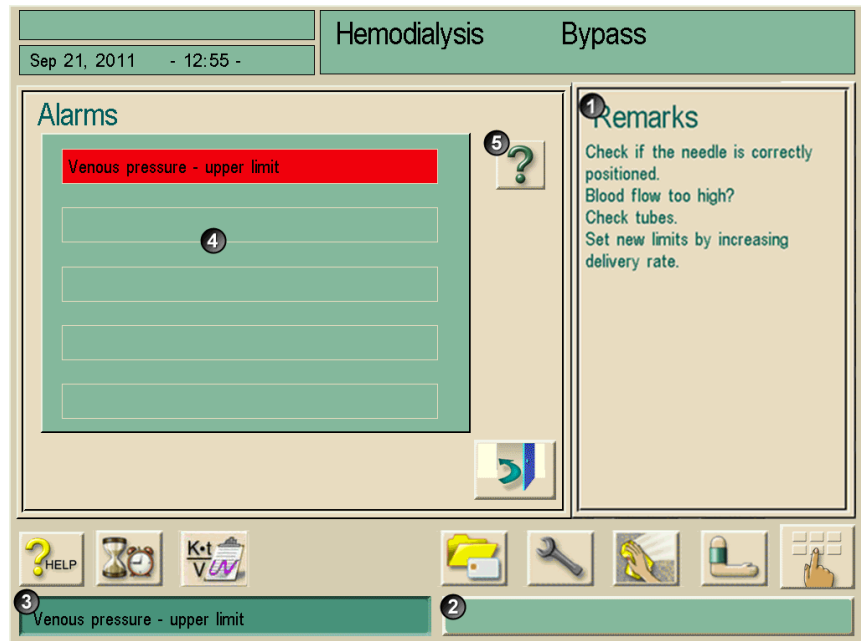

Fig. 13-1 Alarm display

- Alarms are displayed in alarm field **3**.
- The background of the alarm field changes from green to red.
- An acoustic signal is triggered.
- Signal lights on screen change to red.



The service technician can activate an alternative alarm sound in the TSM, which differs from the continuing alarm sound in an alternating melody.



At failure or disturbance of the loudspeaker, the security system will activate the power supply buzzer to report an alarm acoustically. Please inform your service technician.



Alarms are shown in the alarm list in the order of their occurrence. The triggering alarm is shown in the alarm field.

Upon resetting the triggering alarm all subsequent alarms are also deleted.



The user is responsible for the reset of an alarm and subsequently for the monitoring of the suppressed parameters of the dialysis machine.

Resetting a blood-side alarm

- Press "Reset alarm" button.

The acoustic signal is switched off.

- Remedy the cause(s) of the alarm.

- Press "Reset alarm" button.

The dialysis machine is reset to its previous operating condition.

Resetting a dialysate-side alarm

- Press "Reset alarm" button.

The acoustic signal is switched off.

The background color of the alarm field changes from red to yellow.

Alarms on the dialysate-side are automatically reset once the cause of the alarm has been removed.



Warnings or information appear in information window **2**. Information field **2** flashes when more than one information notice has been triggered.

The information field **1** also contains a code number. Note down the code number, in case you need to contact technical service with possible questions.

- Touch information field **2**.

The alarm list **4** is displayed.

**Operation in case of monitor failure**

In case of a failure of the monitor or touch-screen function, all monitoring functions and the signal lamps on the monitor remain active.

To prevent any disconcertion of the operator and patient, it is recommended to terminate the therapy. This requires particular attention of the operator.

The blood pump can be controlled via the +/- keys and the START/STOP key.

In case of alarms, special attention must be paid to the blood tubing system and the air trap in front of the SAD. An alarm may only be reset when the user has verified that the venous patient line does not contain any air.

13.2 Alarms and consequences

Alarm/message/code	Machine Alert	Cause of Alarm	User Action	Machine reaction
Treatment Operation Manager Alarms				
System restored after power failure (Code 600)	- Acoustic alarm - Red light	- Power failure and startup	- Press AQ twice - Reestablish power supply	Alarm message sent to TLC.
TLC Alarms				
(SUP) Comm. Malfunction System Error (Code 1805)	- Acoustic alarm - Red light	Safety confirmation window opening/closing time >10 seconds	- Press AQ twice - Contact technical service	Alarm message sent to TLC.
Actual UF volume deviation (Code 1816)	- Acoustic alarm - Red light	UF volume measured by Supervisor exceeds required volume >150 mL	- Decrease UF volume - Increase time - Contact technical service	Alarm message sent to TLC. Bypass.
UF volume too high (Code 1821)	- Acoustic alarm - Red light	- measured UF volume is too high	- Press EQ button - Check patient weight - Contact technical service	Alarm message sent to TLC. Bypass.
Patient connected? (Code 1824)	- Acoustic alarm - Red light	blood detection for the first time in therapy	- Press AQ button twice - Check if patient is connected properly - Check if machine is in therapy mode	Alarm message sent to TLC. Blood pump stops.
High UF volume error-terminate dialysis (Code 1826)	- Acoustic alarm - Red light	UF volume deviates more than 400 mL	- End of therapy - Contact technical service	Alarm message sent to TLC. Bypass.
Ration gross UF/blood flow too low (Code 2059)	- Acoustic alarm - Red light	UF rate exceeds a defined percentage of the blood flow	- Press AQ button twice - Decrease UF volume - Increase blood pump - Extend therapy time	Alarm message sent to TLC. Bypass.
Blood detected in preparation/disinfection (Code 1831)	- Acoustic alarm - Red light	Venous red detector shows blood either in Preparation or Disinfection	- Press AQ button twice - Change into therapy - Disconnect patient from machine	Alarm message sent to TLC. Blood pump stops.

Alarm/message/code	Machine Alert	Cause of Alarm	User Action	Machine reaction
TLC Warnings				
The selected interval is over (Code 1900)	- Acoustic signal - Yellow light	Profile interval time of any profile is already reached	- Select different interval.	Warning message sent to TLC.
Selected UF volume too high (Code 1903)	- Acoustic signal - Yellow light	The set required UF volume is more than the removable one	- Decrease UF volume.	Warning message sent to TLC. Set required UF volume is refused.
Selected UF volume too low (Code 1904)	- Acoustic signal - Yellow light	The set required UF volume is less than the removable one	- Increase UF volume.	Warning message sent to TLC. Set required UF volume is refused.
Selected UF time too high (Code 1905)	- Acoustic signal - Yellow light	The set required UF time is more than the removable one	- Decrease UF time.	Warning message sent to TLC. Set required UF time is refused.
Selected UF time too low (Code 1906)	- Acoustic signal - Yellow light	The set required UF time is less than the removable one	- Increase UF time.	Warning message sent to TLC. Set required UF time is refused.
Interval cannot be modified (Code 1907)	- Acoustic signal - Yellow light	The last interval was selected in the UF profile editor	- Do not modify last interval.	Warning message sent to TLC. Interval modification is refused.
Max UF rate has profile modified (Code 1908)	- Acoustic signal - Yellow light	UF profile shape is modified by the automatic limitation by minimum or maximum UF rate	- Change UF rate.	Warning message sent to TLC.
Selected heparin rate too high (Code 1911)	- Acoustic signal - Yellow light	Set required heparin rate value is >10 mL/h or corresponding IE/h value	- Decrease heparin rate.	Warning message sent to TLC. Set required heparin rate value is refused.
Selected heparin rate too low (Code 1912)	- Acoustic signal - Yellow light	Set required heparin rate value is < minimum (calculated from minimum feed 0.000001 mL/h and the syringe inner diameter)	- Increase heparin rate.	Warning message sent to TLC. Set required heparin rate value is refused.
Required UF volume too high (Code 1913)	- Acoustic signal - Yellow light	Remaining UF volume is more than the removable one	- Decrease UF volume. - Extend therapy time.	Warning message sent to TLC.

Alarm/message/code	Machine Alert	Cause of Alarm	User Action	Machine reaction
TLC Warnings				
Selected UF rate too low (Code 1914)	- Acoustic signal - Yellow light	Remaining UF volume is less than the removable one	- Increase UF volume. - Reduce therapy time.	Warning message sent to TLC.
UF profile was modified (Code 1915)	- Acoustic signal - Yellow light	The calculated UF rate for process control is limited by minimum or maximum UF rate	- Change UF rate.	Warning message sent to TLC.
Max. UF rate too high (Code 1916)	- Yellow light	The set required UF rate is > 3000 mL/h (absolute limit)	- Decrease UF rate.	Warning message sent to TLC. Set required UF rate value is refused.
Max UF rate < min UF rate +100 mL/h (Code 1917)	- Acoustic signal - Yellow light	Required UF rate max is less than required UF rate min plus spare or less than required volume min divided by required therapy time	- Increase maximum UF rate.	Warning message sent to TLC. Set required UF rate maximum is refused.
UF volume has been decreased (Code 1922)	- Acoustic signal - Yellow light	Required UF volume is reduced automatically by required UF rate max reduction	- Decrease UF volume. - Extend therapy time.	Warning message sent to TLC.
Therapy time has elapsed (Code 1923)	- Acoustic signal (unique End of Therapy sound) - Yellow light	Actual therapy time > required therapy time	- Disconnect patient from machine.	Warning message sent to TLC.
Rinsing volume attained (Code 1927)	- Acoustic signal - Yellow light	Actual dialyzer rinsing volume reached the required one	- No response required.	Warning message sent to TLC.
Connect disposable to recirculation (Code 1928)	- Acoustic signal - Yellow light	Actual dialyzer rinsing bag volume reached the required one	- Start blood pump.	Warning message sent to TLC. Blood pump stops.
Rinsing time too long (Code 1934)	- Acoustic signal - Yellow light	Required rinsing time value is more than the adjustable maximum	- Decrease rinsing time.	Warning message sent to TLC. Set required rinsing time value is refused.
Rinsing time too short (Code 1935)	- Acoustic signal - Yellow light	Required rinsing time value is less than the adjustable minimum	- Increase rinsing time.	Warning message sent to TLC. Set required rinsing time value is refused.
UF rinsing volume too high (Code 1936)	- Acoustic signal - Yellow light	Required rinsing volume is more than the adjustable maximum	- Decrease rinsing time.	Warning message sent to TLC. Set required rinsing volume value is refused.
UF rinsing volume too low (Code 1937)	- Acoustic signal - Yellow light	Required rinsing volume is less than the adjustable minimum	- Increase rinsing time.	Warning message sent to TLC Set required rinsing volume value is refused.

Alarm/message/code	Machine Alert	Cause of Alarm	User Action	Machine reaction
TLC Warnings				
Ack. data before connecting patient (Code 1942)	- Acoustic signal - Yellow light	"Start Therapy" button is selectable, because filling and procedure is finished	- Check data and confirm.	Warning message sent to TLC.
Bypass >2 minutes (Code 1943)	- Acoustic signal - Yellow light	"Manual Bypass Request" button is pushed more than 2 minutes, LLC in Bypass state	- Check situation, keep Manual Bypass button pushed or switch back to main connection.	Warning message sent to TLC.
Longer than 5 minutes in termination (Code 1944)	- Acoustic signal - Yellow light	Time in End of Therapy more than 10 minutes	- Disconnect patient from machine.	Warning message sent to TLC.
No heparin bolus (Code 2056)	- Acoustic signal - Yellow light	Automatic heparin bolus can not be started, because the required heparin bolus volume is zero	- Increase heparin bolus volume.	Warning message sent to TLC.
Minimum UF active (Code 2057)	- Acoustic signal - Yellow light	Manual Minimum UF button is pushed during therapy	- Check situation, keep Minimum UF button pushed or switch back to set UF.	Warning message sent to TLC.
Ratio gross – UF/blood flow too low (Code 2059)	- Acoustic signal - Yellow light	UF rate exceeds a defined percentage of blood flow	- Increase UF rate. - Decrease blood flow rate.	Warning message sent to TLC.
Please press longer EQ button again (Code 2060)	- Acoustic signal - Yellow light	The confirmation window is not displayed by the LLS at the time of the EQ confirmation or the LLS did not detect the EQ confirmation	- Press ↵ button again.	Warning message sent to TLC.
UF removal too low (Code 2064)	- Yellow light	Low temporary removal from patient (required UF volume - actual UF volume >200 mL)	- No response required.	Warning message sent to TLC.
Please start the blood pump! (Code 2067)	- Acoustic signal - Yellow light	Dialyzer rinsing button is pushed and blood side is stopped by the user	- Start blood pump.	Warning message sent to TLC.
HDF/UF alarm limits expanded (Code 2070)	- Yellow light	Any of the UF TLC or LLS alarm limits have been expanded	- No response required.	Warning message sent to TLC.
Rinsing rate too low (Code 2073)	- Acoustic signal - Yellow light	Required rinsing rate is less than the adjustable minimum	- Decrease rinsing time. - Increase rinsing rate.	Warning message sent to TLC. Set required rinsing rate value is refused.

Alarm/message/code	Machine Alert	Cause of Alarm	User Action	Machine reaction
TLC Warnings				
Rinsing rate too high (Code 2074)	- Acoustic signal - Yellow light	Required rinsing volume is more than the adjustable minimum	- Increase rinsing time. - Decrease rinsing rate.	Warning message sent to TLC. Set required rinsing rate value is refused.
A-bolus finished/interrupted (Code 2086)	- Acoustic signal - Yellow light	The arterial bolus is manually/automatically finished or interrupted	- Press EQ button. - If automatically finished/interrupted try again or contact technical service.	Warning message sent to TLC.
Min. UF rate > max. UF rate –100 mL/min (Code 2087)	- Acoustic signal - Yellow light	Set required UF rate minimum is more than required UF rate maximum –100 mL/min	- Increase minimum UF rate.	Warning message sent to TLC. Set required minimum UF rate value is refused.
Heparin stop time decreased (Code 2099)	- Acoustic signal - Yellow light	The required heparin stop time is reduced automatically by required therapy time reduction	- Reduce heparin stop time. - Extend therapy time.	Warning message sent to TLC.
SN active! Ven. level correct? (Code 2100)	- Acoustic signal - Yellow light	- Reinfusion is interrupted - SN clamp or SN Cross Over is selected	- Deactivate SN and take out the SN pump segment or - Restart the reinfusion.	Warning message sent to TLC.

Alarm/message/code	Machine Alert	Cause of Alarm	User Action	Machine reaction
LLS-Alarm				
Bicarbonate mixing ratio (SUP) (Code 1950)	- Acoustic alarm - Red light	The deviation of the calculated bicarbonate mixing ratio from the TSM setting is too high or Bic pump I running in acetate mode	- Press AQ button twice. - Check bicarbonate solution. - Check correct mode (bic/acetate). - If unclearable, contact technical service.	Alarm message sent to TLC. Bypass.
Final conductivity limit (SUP) (Code 1951)	- Acoustic alarm - Red light	Final conductivity deviation is greater than +/-5%	- Press AQ button twice. - If unclearable, contact technical service.	Alarm message sent to TLC. Bypass.
Check AV line for PA monitoring (SUP) (Code 1980)		A connection of the arterial line was not detected at PA.	- If an AV line for pressure measuring is present, please connect it to the PA pressure sensor.	
Temperature too high (SUP) (Code 1952)	- Acoustic alarm - Red light	The temperature is above 41 °C/106 °F	- Press AQ button twice. - If unclearable, contact technical service.	Alarm message sent to TLC. Bypass.
Max. UF rate exceeded (Code 1953)	- Acoustic alarm - Red light	UF rate greater than the selected limit (max. 3000 mL/min) or +10 %	- Press AQ button twice. - Increase therapy time or - Increase max. UF rate or - Decrease UF volume.	Alarm message sent to TLC. Bypass.
Blood leak (SUP) (Code 1955)	- Acoustic alarm - Red light	TSM setting: standard limit (0.5 mL/min at Hct 0.45) Sensor value or measured blood flow is out of limits	- Press AQ button twice. - Check dialyzer and dialyzer tubes for blood. - If blood is visible, change dialyzer. - If alarm remains, contact technical service	Alarm message sent to TLC. Bypass. Blood pump stops.
Venous pressure upper limit (SUP) (Code 1956)	- Acoustic alarm - Red light	Venous pressure greater than maximum (depending on blood pump speed and therapy sub phase)	- Press AQ button twice. - Check blood line for kinking. - Check the correct position of needle or catheter. - Check venous bubble catcher for clots. - Set new limits by reducing blood pump speed.	Alarm message sent to TLC. Bypass. Blood pump stops.

Alarm/message/code	Machine Alert	Cause of Alarm	User Action	Machine reaction
LLS-Alarm				
Blood pump is stationary (SUP) (Code 1957)	- Acoustic alarm - Red light	No blood pump impulse or in SN Cross Over no BPV impulse for more than 2 minutes	- Press AQ button twice. - If restart of blood pump failed, disconnect patient, reinfuse manually. - Contact technical service.	Alarm message sent to TLC. Bypass. Blood pump stops.
S.A.D. (SUP) (Code 1958)	- Acoustic alarm - Red light	Too much air in blood line detected	- Press AQ button twice. - Check blood line for air. - Check blood line for correct placement in the S.A.D. - Follow the instructions of the alarm window.	Alarm message sent to TLC. Bypass. Blood pump stops. Venous clamp closes.
Venous pressure lower limit (SUP) (Code 1959)	- Acoustic alarm - Red light	Venous pressure lower than minimum (depending on blood pump speed and therapy sub phase)	- Press AQ button twice. - Check the correct position of needle or catheter. - Check blood line for disconnection and leakages. - Set new limits by raising blood pump speed.	Alarm message sent to TLC. Bypass blood pump stops. Venous clamp closes.
System error in the supervisor (Code 1960)	- Acoustic alarm - Red light	Communication error in receiving data from TLC or LLC	- Press AQ button twice. - Contact technical service.	Alarm message sent to TLC. Bypass. Blood pump stops. Stop watchdog signal from power supply. Activate buzzer.
S.A.D: Sensor error (SUP) (Code 1961)	- Acoustic alarm - Red light	no air test impulses detected in 1.5 seconds	- Press AQ button twice. - Disconnect patient. - Contact technical service.	Alarm message sent to TLC. Bypass. Blood pump stops. Venous clamp closes.
S.A.D Function Ref. (SUP) (Code 1962)	- Acoustic alarm - Red light	Reference voltage for S.A.D air detector out of limits	- Press AQ button twice. - Switch off/on device. - If alarm persists, disconnect patient and contact technical service.	Alarm message sent to TLC. Bypass. Blood pump stops. Venous clamp closes.

Alarm/message/code	Machine Alert	Cause of Alarm	User Action	Machine reaction
TLC Warnings				
PV lower limit (SUP) (Code 1963)	- Acoustic alarm - Red light	only in SN mode: change of PV is lower than 30 mmHg	- Press AQ button twice. - Check the correct position of needle or catheter. - Check blood line for disconnection and leakages. - Set new venous alarm limits. - Change blood pump speed.	Alarm message sent to TLC. Bypass. Blood pump stops. Venous clamp closes.
SN-pump control pres. failed (PBS) (SUP) (Code 1964)	- Acoustic alarm - Red light	only in SN Cross Over mode: PBS is out of limits	- Press AQ button twice. - Check correct position of PBS transducer. - Leave SN Cross Over mode. - Contact technical service.	Alarm message sent to TLC. Bypass. Blood pump stops.
UF time exceeded (SUP) (Code 1965)	not used since LLS 7.22	not used since LLS 7.22	not used since LLS 7.22	not used since LLS 7.22
UF volume exceeded (SUP) (Code 1966)	- Acoustic alarm - Red light	measured UF volume exceeds limit (UF volume > max UF volume + 200 mL)	- Press AQ button twice. - Disconnect patient, weight control.	Alarm message sent to TLC. Bypass.
Disinfectant valve open! (SUP) (Code 1967)	- Acoustic alarm - Red light	Disinfectant valve VD is open	- Press AQ button twice. - Disconnect patient. - Contact technical service.	Alarm message sent to TLC. Bypass.
Safety data not confirmed! (SUP) (Code 1968)	- Acoustic alarm - Red light	any of the safety parameters is not marked as checked	- Press AQ button twice. - Repeat check. - Contact technical service.	Alarm message sent to TLC. Bypass.
Start without self test (SUP) (Code 1969)	- Acoustic alarm - Red light	any of the self tests is not marked as done	- Press AQ button twice. - Switch off/on device. - If alarm persists, disconnect patient and contact technical service.	Alarm message sent to TLC. Bypass. Blood pump stops. Venous clamp closes.

Alarm/message/code	Machine Alert	Cause of Alarm	User Action	Machine reaction
TLC Warnings				
Internal memory failure (SUP) (Code 1970)	- Acoustic alarm - Red light	CRC error in calibration structure	- Contact technical service.	Alarm message sent to TLC. Bypass. Blood pump stops. Venous clamp closes.
Hardware error RAM/ROM (SUP) (Code 1971)	- Acoustic alarm - Red light	error in ROM, RAM or MPU test during startup	- Contact technical service.	Alarm message sent to TLC. Bypass. Blood pump stops. Venous clamp closes.
SN phase volumes >100 mL (SUP) (Code 1972)	- Acoustic alarm - Red light	only in SN mode: measured phase volume >100 mL and blood pump is running	- Press AQ button twice. - Check blood line for leakages. - Adapt blood pump speed.	Alarm message sent to TLC. Bypass. Blood pump stops. Venous clamp closes.
Main phase change error (SUP) (Code 1973)	- Acoustic alarm - Red light	TLC and LLS are not both in therapy phase	- Press AQ button twice. - Contact technical service.	Alarm message sent to TLC. Bypass. Blood pump stops. Activate buzzer.
Venous pump speed deviation (SUP) (Code 1974)	- Acoustic alarm - Red light	only in SN mode: blood pumps are running too fast (>600 mL/min) or BPV > 2* BPA	- Press AQ button twice. - Decrease blood pumps. - If alarm persists, leave SN mode and contact technical service.	Alarm message sent to TLC. Bypass.
Wrong direction of valves DFS (SUP) (Code 1975)	- Acoustic alarm - Red light	The chamber valves are not set correctly for chamber mode and VDE or VDA is open	- Press AQ button twice. - Contact technical service.	Alarm message sent to TLC. Bypass.
Arterial pressure - lower limit (SUP) (Code 1976)	- Acoustic alarm - Red light	Arterial pressure is lower than the limit	- Press AQ button twice. - Check the correct position of needle or catheter. - Check blood line for disconnection and leakages. - Reduce blood pump speed.	Alarm message sent to TLC. Bypass. Blood pump stops.

Alarm/message/code	Machine Alert	Cause of Alarm	User Action	Machine reaction
TLC Warnings				
Checked data crashed (SUP) (Code 1978)	- Acoustic alarm - Red light	CRC error in power fail data block with all safety parameters	- Press AQ button twice. - Contact technical service.	Alarm message sent to TLC. Bypass. Blood pump stops.
Blood leak (SUP) (Code 1981)	- Acoustic alarm - Red light	TSM setting: (0.35 mL/min at Hct 0.25) Sensor value or measured blood flow is out of limits	- Press AQ button twice. - Check dialyzer and dialyzer tubes for blood. - If blood is visible, change dialyzer. - If alarm remains contact technical service.	Alarm message sent to TLC. Bypass. Blood pump stops.
Connect patient: delivered blood volume >450 mL (Code 2014)	- Acoustic alarm - Red light	Measured blood volume in Therapy sub phase "Connect patient" >450 mL	- Press AQ button twice. - Connect patient. - Reinfuse lost blood from saline bag.	Alarm message sent to TLC. Bypass. Blood pump stop.
Reinfusion: delivered blood volume >450 mL (Code 2015)	- Acoustic alarm - Red light	Measured blood volume in Reinfusion sub phase "Connect patient" >450 mL	- Press AQ button twice. - Disconnect patient. - Check reinfusion volume. - Weight control.	Alarm message sent to TLC. Bypass. Blood pump stops.
Art. Bolus volume exceeded by 200 mL (Code 2026)	- Acoustic alarm - Red light	BPA volume >300 mL in sub phase Arterial Bolus	- Press AQ button twice. - Stop arterial bolus. - Patient weight control. -	Alarm message sent to TLC. Bypass. Blood pump stops.
Mainflow/bypass valves failure (SUP) (Code 2027)	- Acoustic alarm - Red light	Therapy: VDE, VDA and VBP are opened at the same time End of Therapy: VDE and VDA are open Emptying dialyzer: VDE is open	- Press AQ button twice. - Contact technical service.	Alarm message sent to TLC. Bypass.
SUP: blood pump is running (Code 2028)	- Acoustic alarm - Red light	BPA impulses in sub phase "dialyzer emptying"	- Change to disinfection.	Alarm message sent to TLC. Bypass. Blood pump stops. Venous clamp closes.

Alarm/message/code	Machine Alert	Cause of Alarm	User Action	Machine reaction
TLC Warnings				
SUP: data out of range (Code 2029)	- Acoustic alarm - Red light	one of the safety parameters is out of range	- Press AQ button twice. - Change parameter.	Changed parameters can not be acknowledged and parameter window is not opened.
System error – see HELP! (Code 2033)	- Acoustic alarm - Red light	Alarm tone is not activated by TLC when any alarm is set by LLS	- Press AQ button twice. - Switch off/on machine. - If alarm remains contact technical service.	Alarm message sent to TLC. Bypass. Blood pump stops. Activate buzzer.
AQ –button sticks (Code 2036)	- Acoustic alarm - Red light	ENTER button is pressed for longer than 15 seconds	- Switch off/on machine. - If alarm remains contact technical service.	Alarm message sent to TLC. Bypass. Blood pump stops. Venous clamp closes.
SUP: OSD red check failed (Code 2038)	- Acoustic alarm - Red light	Left or right OSD is not activated when any LLS alarm is set	- Press AQ button twice. - Contact technical service.	Alarm message sent to TLC. Bypass. Blood pump stops. Venous clamp closes.

Alarm/message/code	Machine Alert	Cause of Alarm	User Action	Machine reaction
ABPM Alarms				
ABPM: Systolic pressure too high (Code 9100)	- Acoustic alarm - Red light	Systolic blood pressure measured by ABPM is higher than set value	- Press AQ button twice. - Repeat measurement. - Adapt limit values. - Inform doctor.	Alarm message sent to TLC.
ABPM: Systolic pressure too low (Code 9101)	- Acoustic alarm - Red light	Systolic blood pressure measured by ABPM is lower than set value	- Press AQ button twice. - Repeat measurement. - Adapt limit values. - Inform doctor.	Alarm message sent to TLC.
ABPM: Diastolic pressure is too high (Code 9103)	- Acoustic alarm - Red light	Diastolic blood pressure measured by ABPM is higher than set value	- Press AQ button twice. - Repeat measurement. - Adapt limit values. - Inform doctor.	Alarm message sent to TLC.
ABPM: Diastolic pressure is too low (Code 9104)	- Acoustic alarm - Red light	Diastolic blood pressure measured by ABPM is lower than set value	- Press AQ button twice. - Repeat measurement. - Adapt limit values. - Inform doctor.	Alarm message sent to TLC.
ABPM: Internal communication disturbed (Code 9138)	- Acoustic alarm - Red light	ABPM module did not respond	- Press AQ button twice. - Use separate blood pressure device. - Contact technical service.	Alarm message sent to TLC.
ABPM: Pulse rate too high (Code 9169)	- Acoustic alarm - Red light	Pulse rate measured by ABPM is higher than set value	- Press AQ button twice. - Repeat measurement. - Adapt limit values. - Inform doctor.	Alarm message sent to TLC.
ABPM: Pulse rate too low (Code 9170)	- Acoustic alarm - Red light	Pulse rate measured by ABPM is lower than set value	- Press AQ button twice. - Repeat measurement. - Adapt limit values. - Inform doctor.	Alarm message sent to TLC.

Alarm/message/code	Machine Alert	Cause of Alarm	User Action	Machine reaction
ABPM Alarms				
ABPM: Service (S/04) (Code 9154)	- Acoustic alarm - Red light	By ABPM module detected single failure transmission with xxx error code	- Press AQ button twice. - Repeat measurement. - Contact technical service.	Alarm message sent to TLC.
ABPM: Air leak – check cuff connection (Code 9300)	- Acoustic alarm - Red light	Cuff pressure <3 mmHg 10 seconds relative to reading start	- Press AQ button twice. - Check cuff connection.	Alarm message sent to TLC.
ABPM: Module failure please switch off/on (Code 9301)	- Acoustic alarm - Red light	The safety CPU of the ABPM module detects a failure condition.	- Press AQ button twice. - Switch machine off/on. - If alarm persists contact technical service.	Alarm message sent to TLC. Message 9172 remains on the display after confirmation.
ABPM: Inflation pressure not reached (Code 9302)	- Acoustic alarm - Red light	The cuff pressure did not reach a specified level of inflation in a given time (30 seconds)	- Press AQ button twice. - Check cuff seat. - Repeat measurement.	Alarm message sent to TLC.
ABPM: Pulsation not detected (Code 9303)	- Acoustic alarm - Red light	The pressure dropped to 10 mmHg but the measurement is not completed	- Press AQ button twice. - Check cuff seat. - Measure the pulse manually. - If low inform doctor.	Alarm message sent to TLC.
ABPM: Excessive arm movement (Code 9304)	- Acoustic alarm - Red light	The air was not discharged for longer than 15 seconds because of body movements	- Press AQ button twice. - Ask the patient not to move during the measurement or hold the arm. - Repeat measurement.	Alarm message sent to TLC.

Alarm/message/code	Machine Alert	Cause of Alarm	User Action	Machine reaction
ABPM Alarms				
ABPM: Pulse measurement disturbed (Code 9306)	- Acoustic alarm - Red light	ABPM detects abnormal oscillometric wave form	- Press AQ button twice. - Check cuff seat. - Measure the pulse manually.	Alarm message sent to TLC.
ABPM: Irregular pulse (Code 9307)	- Acoustic alarm - Red light	Impossible to measure pulse due to arrhythmia, noise or body movement	- Press AQ button twice. - Check cuff seat. - Measure the pulse manually. - If pulse is arrhythmic inform doctor.	Alarm message sent to TLC.
ABPM: Reading took too long (Code 9308)	- Acoustic alarm - Red light	Measurement took more than 90 seconds (PAR) or 160 seconds	- Press AQ button twice. - Repeat measurement with separate blood pressure device.	Alarm message sent to TLC.
ABPM: Pulse over 100 beats (Code 9309)	- Acoustic alarm - Red light	Pulse over 100 beats or 160 beats or 240 beats in adult setting PAR: not used	- Press AQ button twice. - Repeat measurement with separate blood pressure device.	Alarm message sent to TLC.
ABPM: Cuff pressure > 320mmHg (Code 9310)	- Acoustic alarm - Red light	Cuff pressure exceeds 320 mmHg/ 300 mmHg (PAR)	- Press AQ button twice. - Repeat measurement. - Make sure patient's arm is not bent. - Repeat measurement with separate blood pressure device.	Alarm message sent to TLC.
ABPM: Pulse signal very low (Code 9311)	- Acoustic alarm - Red light	Pulse amplitude is too low to measure	- Press AQ button twice. - Repeat measurement. - Repeat measurement with separate blood pressure device. - If still low inform doctor.	Alarm message sent to TLC.

Alarm/message/code	Machine Alert	Cause of Alarm	User Action	Machine reaction
ABPM Alarms				
ABPM: Large pressure transient (Code 9312)	- Acoustic alarm - Red light	Sharp pressure spike occurs during measurement cycle	- Check cuff tubing for kinking. - Check cuff connection to patient. - Make sure arm is not moved. - Repeat measurement.	Alarm message sent to TLC.
ABPM: Not defined error code (Code 9313)	- Acoustic alarm - Red light	Not specified	- Check cuff tubing for kinking. - Check cuff connection to patient. - Make sure arm is not moved. - Repeat measurement.	Alarm message sent to TLC.

Alarm/message/code	Machine Alert	Cause of Alarm	User Action	Machine reaction
ABPM Warnings				
ABPM: Body movement (Code 9119)	- Acoustic signal - Yellow light	Motion artifact is detected by ABPM module	- Ask the patient not to move during the measurement or hold the arm. - Repeat measurement.	Warning message sent to TLC.
ABPM: wait.. (Code 9162)	- Acoustic signal - Yellow light	New reading is starting within 30 seconds after completion of the last measurement	- Wait and check cycle interval.	Warning message sent to TLC.
ABPM: Reading interrupted (Code 9171)	- Acoustic signal - Yellow light	The user interrupted the current ABPM reading releasing the ABPM reading button	- Repeat measurement.	Warning message sent to TLC.
ABPM: Switched off – module fault (Code 9172)	- Acoustic signal - Yellow light	The safety CPU of the ABPM module detects a failure condition	- Switch machine off/on. - If alarm consists contact technical service.	Warning message sent to TLC. Is displayed after confirmation of alarm 9301.
ABPM: Check alarm limits (Code 9173)	- Acoustic signal - Yellow light	Message always appears after first successful ABPM reading	- Check alarm limits.	Warning message sent to TLC.

Alarm/message/code	Machine Alert	Cause of Alarm	User Action	Machine reaction
DISINF_MGR Alarms				
Solution intake failed (Code 1401)	- Acoustic alarm - Red light	If sensor LAFSU does not recognize conductivity after the intake phase	- Check disinfectant canister. - Rinse out and retry to intake right amount of disinfectant.	Warning message sent to TLC.
Timeout temperature not reached (Code 1402)	- Acoustic alarm - Red light	If the temperature in the fluid system does not achieve the set point within 15 minutes	- Waiting to achieve the temperature. - Contact technical service.	Warning message sent to TLC.

13

Alarm/message/code	Machine Alert	Cause of Alarm	User Action	Machine reaction
DISINF_MGR Warnings				
Temperature too high (Code 1420)	- Acoustic signal - Yellow light	If actual temperature is higher than set point +10 °C/50 °F for 15 seconds	- Contact technical service.	Warning message sent to TLC.
Temperature too low (Code 1421)	- Acoustic signal - Yellow light	If actual temperature is less than setpoint -10 °C/14 °F for 15 seconds	- Contact technical service.	Warning message sent to TLC.
LF too low (check disinfectant) (Code 1422)	- Acoustic signal - Yellow light	If actual conductivity is less than set point for 15 seconds	- Check disinfectant canister. - Contact technical service.	Warning message sent to TLC.
Last disinfection with disturbance? (Code 1423)	- Acoustic signal - Yellow light	Alarm and warnings during the last disinfectant which can influence the effect of the disinfection	- Press EQ button. - Check disinfectant canister. - Repeat disinfection.	Warning message sent to TLC.
Please select method (Code 1424)	- Yellow light	the phase rinse out is finished and the user has not selected a method	- Select a method.	Warning message sent to TLC.
It is disinfectant in the device (Code 1425)	- Acoustic signal - Yellow light	After an automatic switch-on, one of the methods "Central thermal rinsing" or "Central rinsing" is selected but the machine is not concentrate or disinfectant free	- Rinse the machine with water before selecting one of the methods.	Warning message sent to TLC.
Bic pump has stopped (Code 1426)	- Acoustic signal - Yellow light	In circulation or rinsing phase the Bic pump is controlled by the LLC but the signal of LLS is 0	- Contact technical service.	Warning message sent to TLC.
Disinf Warning #7 (Code 1427)	- Yellow light	In method "Central chemical" the phase "Solution intake" is ended by < timing or manual deactivation	- Repeat disinfection.	Warning message sent to TLC.
Device rinsing finished (Code 1428)	- Yellow light	In method "Central chemical" the phase "Solution intake" is ended by < timing or manual deactivation	- Repeat disinfection.	Warning message sent to TLC.

Alarm/message/code	Machine Alert	Cause of Alarm	User Action	Machine reaction
Kt/V Warnings				
When not using Adimea™: Kt/V target will not be reached (Code 1550)	- Yellow light	The projected estimated Kt/V value is less than the target one	- Extend therapy time or increase BP speed.	Warning message sent to TLC.
Adimea: Entered Target Kt/V will not be reached (Code 1556)	- Yellow light	The projected estimated Kt/V value is less than the target one	- Extend therapy time or increase BP speed.	Warning message sent to TLC.
Adimea: Sensor not calibrated (Code 1551)	- Yellow light, disappearing after 20 seconds	Communication error	- Call technician.	Warning message sent to TLC. Value substituted by "-.-".
Adimea: Sensor not connected (Code 1552)	- Yellow light, disappearing after 20 seconds	Sensor not connected or physically interrupted	- Call technician.	Warning message sent to TLC. Value substituted by "-.-".
Adimea: Calibration failed (Code 1553)	- Yellow light, disappearing after 20 seconds	Calibration problem	- Call technician.	Warning message sent to TLC. Value substituted by "-.-".
Adimea: Sensor can not warm up (Code 1554)	- Yellow light, disappearing after 20 seconds	Sensor cannot warm up	- Call technician.	Warning message sent to TLC. Value substituted by "-.-".
Adimea: Sensor is disabled (Code 1555)	- Yellow light, disappearing after 20 seconds	The sensor is defective or has been disabled	- Call technician.	Warning message sent to TLC. Value substituted by "-.-".

Alarm/message/code	Machine Alert	Cause of Alarm	User Action	Machine reaction
TLC-UI Alarms				
BP+ button stuck (Code 672)	- Acoustic alarm - Red light	BP+ button pushing time > 25 seconds	- Release button. - If stuck contact technical service.	Alarm message sent to TLC. Blood pump stops.
BP start/stop button stuck (Code 673)	- Acoustic alarm - Red light	BP start/stop button pushing time >10 seconds	- Release button. - If stuck contact technical service.	Alarm message sent to TLC. Blood pump stops.
BP- button stuck (Code 674)	- Acoustic alarm - Red light	BP- button pushing time >25 seconds	- Release button. - If stuck contact technical service.	Alarm message sent to TLC. Blood pump stops.
EQ button stuck (Code 675)	- Acoustic alarm - Red light	EQ button pushing time >10 seconds	- Release button. - If stuck contact technical service.	Alarm message sent to TLC. Blood pump stops.
UF volume is reached (Code 665)	- Acoustic alarm - Red light	Actual UF volume reached the required one	- Press EQ button. - Disconnect patient.	Alarm message sent to TLC. UF volume safety check window open.
UF volume is overrun by 100 mL (Code 666)	- Acoustic alarm - Red light	Actual UF volume exceeded the required one by 100 mL but the actual therapy time not yet reached required one -30 minutes	- Disconnect patient. - Weight control.	Alarm message sent to TLC. UF volume safety check window open. Bypass.

Alarm/message/code	Machine Alert	Cause of Alarm	User Action	Machine reaction
TLC-UI Warnings				
New message! (Code 670)	- Yellow light	New instruction message arrived from DBI	- Read message.	Warning message sent to TLC.
New medication! (Code 671)	- Yellow light	New medication message arrived from DBI	- Read message.	Warning message sent to TLC.
BP+ button stuck (Code 672)	- Acoustic signal - Yellow light	BP+ button pushing time between 20 and 25 seconds	- Release button. - If stuck, contact technical service.	Warning message sent to TLC.
BP start/stop button stuck (Code 673)	- Acoustic signal - Yellow light	BP start/stop button pushing time between 5 and 10 seconds	- Release button. - If stuck, contact technical service.	Warning message sent to TLC.
BP- button stuck (Code 674)	- Acoustic signal - Yellow light	BP button pushing time between 20 and 25 seconds	- Release button. - If stuck, contact technical service.	Warning message sent to TLC.
EQ button stuck (Code 675)	- Acoustic signal - Yellow light	EQ button pushing time between 5 and 10 seconds	- Release button. - If stuck, contact technical service.	Warning message sent to TLC.

Alarm/message/code	Machine Alert	Cause of Alarm	User Action	Machine reaction
TLC-UI Warnings				
AQ button stuck (Code 676)	- Acoustic signal - Yellow light	AQ button pushing time > 5 minutes	- Release button. - If stuck contact technical service.	Warning message sent to TLC.
UF volume increased (Code 677)	- Yellow light	Safety check window is closed at automatic UF volume expansion at the end of therapy (after code 665)	- Press EQ button. - Disconnect patient.	Warning message sent to TLC.
The set time interval expired! (Code 678)	- Acoustic signal (unique for timer) - Yellow light	Set nurse timer interval is expired	- Press AQ button twice. - Perform prompted action or read timer text.	Warning message sent to TLC.
Dialog time differs from server time (Code 679)	- Acoustic signal - Yellow light	The automatically initiated time synchronization on the basis of DBI time has failed (difference >15 minutes)	- Select Therapy or disinfectant mode manually. - Contact technical service.	Warning message sent to TLC.
Timer expired before power return (Code 680)	- Acoustic signal - (unique for timer) - Yellow light	The set nurse timer expired during power failure	- Perform prompted action or read timer text.	Warning message sent to TLC.
+/- 12V Power Supply insufficient (Code 1008)	- Acoustic alarm - Red light	Voltage level +12 V or -12 V is out of range	- Switch off/on machine. - Contact technical service.	Blood pump stops. Heparin pump stops. Bypass. Venous clamp closes.

Alarm/message/code	Machine Alert	Cause of Alarm	User Action	Machine reaction
LLC Alarms				
Mains failure- Battery Backup mode (Code 1009)	- Acoustic alarm - Red light	Power failure, machine runs on battery backup. Power supply indicates missing power for more than 40 milliseconds	- Reestablish power supply.	Bypass.
Temporary communication problem (Code 1010)	- Acoustic alarm - Red light	No message received from TLC to LLS or sent to TLC from LLS for more than 5 seconds	- Switch off/on machine. - If alarm persists, contact technical service.	Blood pump stops. Heparin pump stops. Bypass. Venous clamp closes.
TMP out of alarm limit (Code 1015)	- Acoustic warning - Yellow light	TMP out of alarm window limits, but > -100 mmHg for more than 5 seconds constantly	- Readjust TMP alarm window. - Readjust blood pump speed.	none (display only)
TMP too low (Code 1016)	<u>Preparation:</u> - Acoustic warning - Yellow light <u>Therapy:</u> - Acoustic alarm - Red light	TMP out of alarm window limits, but < -100 mmHg for more than 2 seconds constantly	- Check dialyzer type. - Readjust TMP alarm window. - Increase UF volume. - Increase blood pump speed.	Bypass.
Dialyzer TMP limits exceeded (Code 1017)	<u>Preparation:</u> - Acoustic warning - Yellow light <u>Therapy:</u> - Acoustic alarm - Red light	TMP higher than allowed dialyzer limit for more than 15 seconds constantly	- Check dialyzer for clotting, if necessary change dialyzer. - Decrease UF volume. - Decrease blood pump speed.	UF stop.
DF pressure < -400 mmHg (Code 1020)	<u>Preparation:</u> - Acoustic warning - Yellow light <u>Therapy:</u> - Acoustic alarm - Red light	Sensor PDA < -400 mmHg for 2.5 seconds constantly. System may not be in bypass-state (valve VDA is open) when PDA is first < -400 mmHg	- Check if UF factor of the dialyzer is high enough. - Decrease UF volume. - Increase therapy time.	UF stop.
DF pressure > 400 mmHg (Code 1021)	<u>Preparation:</u> - Acoustic warning - Yellow light <u>Therapy:</u> - Acoustic alarm - Red light	Sensor PDA > +400 mmHg for 2.5 seconds continuously. System may not be in bypass-state (valve VDA is open) when PDA is first > +400 mmHg	- Check dialyzer for clotting, if necessary change dialyzer. - Check tubing system. - Decrease UF volume. - Decrease blood pump speed.	Bypass.

Alarm/message/code	Machine Alert	Cause of Alarm	User Action	Machine reaction
LLC Alarms				
Water supply disturbed (Code 1022)	<u>Preparation and disinfection:</u> - Acoustic warning - Yellow light <u>Therapy:</u> - Acoustic alarm - Red light	Missing water supply: Level sensor in VB below lower level for more than 5 seconds (volume below lower level: 100 mL)	- Check water supply. - Check water tube connection to machine. - Check water pressure.	Bypass. LF-preparation, DF-flow, degassing and heating is stopped. Level-regulation is stopped and restarted.
Malfunction of chamber system sensors (Code 1023)	- Acoustic alarm - Red light	Balance chambers out of range and/or end position of membranes of balance chambers out of range	- Switch off/on machine. - Contact technical service.	Bypass. LF-preparation and DF-flow are stopped, DF-flow is restarted, end-positions of chamber-system have to be determined during the initialization phase.
UF balance? Air leakage in dialyzer coupling (Code 1026)	- Acoustic alarm - Red light	Air leakage: Degasser was filled with air 10 times since the last alarm 1026 or since start of therapy	- Press AQ button. - Check dialyzer connection.	none (display only)
Acetate-acid concentrate empty? (Code 1027)	<u>Preparation:</u> - Acoustic warning - Yellow light <u>Therapy:</u> - Acoustic alarm - Red light	Missing supply of acetate or acid concentrate.	- Check position of rod in container. - Check suction line. - Check concentrate supply.	Bypass. Concentrate pumps stopped.
Bicarbonate conductivity limit (Code 1028)	- Acoustic alarm - Red light	Bicarbonate value out of limits as set by user. The mean deviation value during a chamber cycle > +/-5 %	- Check position of rod in the container. - Check suction line. - Check bicarbonate supply. - If alarm consists contact technical service.	Bypass.

Alarm/message/code	Machine Alert	Cause of Alarm	User Action	Machine reaction
LLC Alarms				
Final conductivity limit (Code 1029)	- Acoustic alarm - Red light	Final conductivity value out of limits as set by user. The mean deviation value during a chamber cycle > +/- 5 %	- Check position of rods in the containers. - Check suction lines. - Check acetate or acid/bicarbonate supply. - If alarm persists, contact technical service.	Bypass.
Bicarbonate mixing ratio (Code 1030)	- Acoustic alarm - Red light	Water/bicarbonate volume ratio out of operation mode dependent limits set by a technician in TSM.	- Check if correct concentrate for the selected operation mode is used. - Check suction lines. - If alarm persists, contact technical service.	Bypass.
Concentrate mixing ratio (Code 1031)	- Acoustic alarm - Red light	Water/acetate or water/acid volume ratio out of operation mode dependent limits as set by a technician in TSM.	- Check if correct concentrate for the selected operation mode is used. - Check suction lines. - If alarm persists, contact technical service.	Bypass.
Bicarbonate empty? (Code 1032)	<u>Preparation:</u> - Acoustic warning - Yellow light <u>Therapy:</u> - Acoustic alarm - Red light	Missing supply of bicarbonate concentrate	- Check position of rod in the container. - Check suction line. - Check bicarbonate supply. - If alarm persists, contact technical service.	Bypass. The limits are read from the calibration-data at startup.
Temperature too low (Code 1033)	<u>Preparation:</u> - Acoustic warning - Yellow light <u>Therapy:</u> - Acoustic alarm - Red light	Measured dialysate temperature is 1 °C/34 °F lower than the desired temperature	- If unclearable, contact technician.	Bypass.
Temperature too high (Code 1034)	<u>Preparation:</u> - Acoustic warning - Yellow light <u>Therapy:</u> - Acoustic alarm - Red light	Measured dialysate temperature is 1 °C/34 °F higher than the desired temperature	- If unclearable, contact technician.	Bypass.

Alarm/message/code	Machine Alert	Cause of Alarm	User Action	Machine reaction
LLC Alarms				
Coupling on dialyzer? (Code 1036)	<u>Preparation:</u> - Acoustic warning - Yellow light <u>Therapy:</u> - Acoustic alarm - Red light	One or both couplings are on the rinse-bridge but must be on dialyzer	- Connect couplings to the dialyzer.	Bypass.
Coupling on rinse bridge? (Code 1037)	<u>Preparation:</u> - Acoustic warning - Yellow light	Preparation before connecting the dialyzer or disinfection	- Connect couplings to rinse bridge.	<u>Preparation:</u> Bypass. <u>Disinfection:</u> DF Flow Stops.
Connect acid/acetate concentrate (Code 1038)	<u>Preparation:</u> - Acoustic warning - Yellow light <u>Therapy:</u> - Acoustic alarm - Red light	DF-preparation required, but the acetate/acid-concentrate suction-tube is inside the rinse chamber	- Connect suction rod to the acid/acetate concentrate.	Bypass.
Connect red concentrate coupling to rinse bridge (Code 1039)	<u>Disinfection only:</u> - Acoustic warning - Yellow light	Disinfection: the acetate/acid-concentrate suction-tube is outside the rinse chamber	- Insert red concentrate suction rod into the unit to start disinfection.	DF Flow Stops.
Connect bicarbonate (Code 1040)	<u>Preparation:</u> - Acoustic warning - Yellow light <u>Therapy:</u> - Acoustic alarm - Red light	DF-preparation with bicarbonate required and cartridge is not inserted and the bicarbonate-concentrate suction-tube is inside the rinse chamber	- Connect suction rod to the bicarbonate concentrate or insert bicarbonate cartridge.	Bypass.
Connect blue concentrate coupling to rinse bridge (Code 1041)	- Acoustic alarm - Red light	Preparation, therapy: In acetate or bicarbonate-cartridge mode bicarbonate suction rod is not in rinse bridge Disinfection: The bicarbonate-concentrate suction-rod is outside the rinse chamber	- Insert blue concentrate suction rod into the unit.	<u>Disinfection:</u> DF Flow Stops. <u>Otherwise:</u> Bypass.
Blood leak >0.35 mL/min (Code 1043)	- Acoustic alarm - Red light	Measured blood concentration exceeds 0.35 mL/min for 30 seconds consecutively.	- Press AQ button. - Check dialyzer and dialyzer tubes for visible blood. - If necessary change dialyzer. - If alarm still remains, contact technical service (sensor damage).	<u>Preparation and End-of-therapy:</u> none (display only). <u>Therapy:</u> Blood pump(s) stop. Heparin pump stops. Bypass.

Alarm/message/code	Machine Alert	Cause of Alarm	User Action	Machine reaction
LLC Alarms				
Blood leak: sensor dirty (Code 1044)	- Acoustic alarm - Red light	Evaluation of sensor BL not finished within 20 seconds	- Press AQ button. - Check dialyzer and dialyzer tubes for visible blood. - If necessary change dialyzer. - If alarm still remains, contact technical service (sensor damage).	none (display only)
Bicarbonate cartridge holder open (Code 1045)	- Acoustic warning - Yellow light	Preparation, therapy: DF-preparation with bicarbonate not selected, but holder open Disinfection: holder open	- Press AQ button. - Close holder.	<u>Preparation, therapy:</u> none (display only). <u>Disinfection:</u> DF Flow Stop.
PBE upper limit (Code 1048)	- Acoustic alarm - Red light	The blood side dialyzer inlet pressure exceeds the set limit	- Press AQ button twice- Adjust blood flow. - Check dialyzer for clotting. - Check tubing system for kinking. - Adapt limits.	Blood pump stops. Heparin pump stops. Bypass.
PBE lower limit (Code 1049)	- Acoustic alarm - Red light	The blood-side dialyzer inlet pressure dropped below 10 mmHg.	- Press AQ button twice. - Check tubing system for leakages.	Blood pump stops. Heparin pump stops. Bypass.
Arterial pressure - upper limit (Code 1050)	- Acoustic alarm - Red light	The arterial suction pressure exceeds the preset arterial upper limit.	- Press AQ button twice. - Check cannula for proper position. - Check patient's access for leakage-free connection. - Adjust blood flow. - Re-adjust limits.	Blood pump stops. Heparin pump stops. Bypass.
Arterial pressure - lower limit (Code 1051)	- Acoustic alarm - Red light	The arterial suction pressure is lower than the preset arterial lower limit.	- Press AQ button twice. - Check patient's access. - Adjust blood flow. - Re-adjust limits. - Correct position of cannula.	Blood pump stops. Heparin pump stop. Bypass.

Alarm/message/code	Machine Alert	Cause of Alarm	User Action	Machine reaction
LLC Alarms				
Venous pressure - upper limit (Code 1052)	- Acoustic alarm - Red light	Venous pressure exceeds upper limit.	- Press AQ button twice. - Check patient's access. - Check venous drip chamber. - Adjust blood flow. - Re-adjust limits. - Correct position of cannula.	Blood pump stops. Heparin pump stops. Bypass.
Venous pressure - lower limit - Check access (Code 1053)	- Acoustic alarm - Red light	Venous pressure is lower than the lower limit.	- Press AQ button twice. - Check patient's access for leakage-free connection. - Restore connection. - Push back fluid column with syringe. - Adjust blood flow.	Blood pump stops. Heparin pump stops. Bypass.
Preparation of new BIC Cartridge-bypass (Code 1054)	- Acoustic warning - Yellow light	After inserting a new bicarbonate cartridge, it takes some time to prepare concentrate from the powder.	- No further action required.	Bypass.
SAD - Air! (Code 1058)	- Acoustic alarm - Red light	Actual accumulated SAD-air-volume measured by the SAD sensor exceeds mode- and blood flow-dependant limit.	- Press AQ button twice. - Check tubing system for air. - Push back fluid column with syringe. - Follow the instructions of the alarm window. - If technical defect contact technical service.	Blood pump stops. Heparin pump stops. Bypass. Venous clamp closes.
SAD - sensor error (Code 1059)	- Acoustic alarm - Red light	Cyclical self-test of SAD sensor not passed	- Press AQ button twice. - Disconnect patient. - Contact technical service.	Blood pump stops. Heparin pump stops. Bypass. Venous clamp closes.

Alarm/message/code	Machine Alert	Cause of Alarm	User Action	Machine reaction
LLC Alarms				
Check heparin pump-put in syringe new (Code 1060)		Heparin pump should run, but no syringe is inserted. (Only with pump type "Comfort", pump type no longer supported.)	<ul style="list-style-type: none"> - Press AQ button twice. - Choose proper heparin syringe type. 	none (display only)
Do not remove the pump tube! (Code 1061)	<ul style="list-style-type: none"> - Acoustic alarm - Red light 	Therapy sub phase "End of Therapy" and SN mode: if venous blood pump cover is open	<ul style="list-style-type: none"> - Press AQ button twice. - Close venous pump cover. 	Blood pump stops. Heparin pump stops. Bypass.
Pump cover open (arterial) (Code 1062)	<ul style="list-style-type: none"> - Acoustic alarm - Red light 	BPA should run and cover is opened	<ul style="list-style-type: none"> - Press AQ button twice. - Close arterial pump cover. 	Blood pump stops. Heparin pump stops. Bypass.
Pump cover open (SN/Subst) (Code 1063)	<ul style="list-style-type: none"> - Acoustic alarm - Red light 	BPV should run and cover is opened except Therapy sub phase "End of Therapy" and SN mode	<ul style="list-style-type: none"> - Press AQ button twice. - Close venous pump cover. 	Blood pump stops. Heparin pump stops. Bypass.
Phase volume too high (Code 1064)	<ul style="list-style-type: none"> - Acoustic alarm - Red light 	SN-valve or SN-Cross Over: phase volume exceeds 80 mL	<ul style="list-style-type: none"> - Press AQ button twice. - Check tubing system for leakages. - Check if tube is placed in the arterial clamp. - Increase blood pump speed. - Adapt switch pressure. 	Blood pump stops. Heparin pump stops. Bypass.
No heparin delivery-syringe empty? (Code 1065)	<ul style="list-style-type: none"> - Acoustic warning - Yellow light 	Heparin pump should be pumping but no rotation signal of the spindle is received (i.e. rotation is blocked)	<ul style="list-style-type: none"> - Press AQ button twice. - Check proper position of syringe. - Check heparin line clamp. - Check if heparin pump is empty. - Insert new syringe. 	none (display only)
Heparin syringe holder open (Code 1066)	<ul style="list-style-type: none"> - Acoustic alarm - Red light 	Syringe was removed from the pump while the blood pump is running	<ul style="list-style-type: none"> - Press AQ button twice. - Check proper position of syringe. - Close syringe holder. 	Blood pump stops. Heparin pump stops. Bypass. Arterial clamp closes.
Phase volume too low - see HELP (Code 1067)	<ul style="list-style-type: none"> - Acoustic warning - Yellow light 	SN-valve: phase volume less than 5 mL SN-Cross Over: phase volume less than 10 mL	<ul style="list-style-type: none"> - Press AQ button twice. - Check patient's access. - Decrease blood pump speed. - Adapt switch pressure. 	none (display only)

Alarm/message/code	Machine Alert	Cause of Alarm	User Action	Machine reaction
LLC Alarms				
Temporary communication problem (Code 1069)	- Acoustic alarm - Red light	No message received from LLS or sent to LLS for more than 5 seconds	- Contact technical service.	Blood pump(s) stop(s). Heparin pump stops. Bypass. Arterial clamp closes.
PBS too low (Code 1070)	- Acoustic alarm - Red light	SN control pressure PBS < -100 mmHg for more than 250 milliseconds	- Press AQ button twice. - Readjust blood pump speed. - Contact technical service.	Blood pump(s) stop(s). Heparin pump stops. Bypass.
PBS too high (Code 1071)	- Acoustic alarm - Red light	SN control pressure PBS > +700 mmHg for more than 250 milliseconds	- Press AQ button twice. - Readjust blood pump speed. - Contact technical service.	Blood pump(s) stop(s). Heparin pump stops. Bypass.
Can not draw in disinfectant (Code 1082)	- Acoustic alarm - Red light	Failure while starting to suck disinfectant (too much air)	- Check disinfectant level in canister. - Check connections to canister.	none (display only)

Alarm/message/code	Machine Alert	Cause of Alarm	User Action	Machine reaction
LLC Warnings				
Temperature for test not reached (Code 1102)	- Yellow message box in the right corner of the display	43 °C/109 °F has not been reached immediately before starting the temperature-self test.	- If warning repeats next treatment, call technician.	Warning message sent to TLC.
Battery is not fully charged (Code 1103)	- Yellow message box in the right corner of the display	If the machine is equipped with the accu option, a cyclical self test of the accu capacity is performed by the power-supply during preparation. If this self test fails, the warning is generated	- If warning repeats next treatment, call technician for checking the accu.	Warning message sent to TLC.
Connect patient – alarm limits open! (Code 1105)	- Yellow message box in the right corner of the display	The connect-patient subphase is active, the venous alarm limits are inactive	- Observe venous pressure, blood line and access, do not leave the patient until therapy starts.	Warning message sent to TLC.
Reinfusion - alarm limits open! (Code 1106)	- Yellow message box in the right corner of the display	The reinfusion subphase is active	- Observe venous pressure, blood line and access, do not leave the patient until disconnected from the machine.	Warning message sent to TLC.
TMP alarm limit reached (Code 1110)	- Yellow message box in the right corner of the display	Alarm 1016 is not active and TMP is lower than lower TMP alarm window border	- Check dialyzer type. - Readjust TMP alarm window. - Increase UF volume. - Increase blood pump speed.	Warning message sent to TLC.
Degassing insufficient (Code 1111)	- Yellow message box in the right corner of the display	Degassing pressure at sensor PE is more positive than desired degassing pressure plus 25mmHg for more than 2 minutes continuously	- If warning repeats next treatment, call technician.	Warning message sent to TLC.
SN level setting - PV too high (Code 1114)	- Yellow message box in the right corner of the display	Set-level function requested and PV > +50 mmHg; SAKV not opened	- Readjust level.	Warning message sent to TLC.
Level setting interrupted by alarm (Code 1115)	- Yellow message box in the right corner of the display	A blood-side alarm occurred that requires closing of SAKA and SAKV occurs during set-level-function	- Clear alarm. - Repeat level setting.	Warning message sent to TLC.

Alarm/message/code	Machine Alert	Cause of Alarm	User Action	Machine reaction
LLC Warnings				
Dialyzing fluid disturbed (Code 1119)	- Yellow message box in the right corner of the display	Dialysate flow deviation > ±10 % of desired value for more than 10 minutes, continuously	- If warning repeats next treatment, call technician.	Warning message sent to TLC.
Please start blood pump! (Code 1140)	- Yellow message box in the right corner of the display - 1x acoustic warning tone	Blood side-self tests should start but the blood pump is stopped by the user	- Start blood pump.	Warning message sent to TLC.
S.A.D alarm switched off (Code 1142)	- Yellow message box in the right corner of the display	Reinfusion in end-of-therapy subphase and SAD-air-error and SAD-disable toggled	- Observe blood line for air during reinfusion. - Do not leave patient until disconnection from machine.	Warning message sent to TLC.
Phase volume too low-see HELP (Code 1146)	- Yellow message box in the right corner of the display - 1x acoustic warning tone	Actual-phase-volume < reference-phase-volume -10 mL. Reference-phase-volume = phase-volume in the third phase after blood-pump-start	- Check patient's access. - Decrease blood pump speed. - Adapt switch pressure.	Warning message sent to TLC.
PBE not connected! (Code 1147)	- Yellow message box in the right corner of the display	Start of therapy phase and the dynamics of pressure-sensor PBE during BS-self tests in preparation has been < 50 mmHg	- Connect PBE sensor line if available. - If blood line has no PBE line, no action is required.	Warning message sent to TLC.
PBE too high (Code 1148)	- Yellow message box in the right corner of the display - 1x acoustic warning tone	A warning window is calculated based on the PBE-value after 10 minutes after starting therapy. The actual PBE-value is higher than the upper warning window limit for more than 30 seconds continuously	- Adjust blood flow. - Check dialyzer for clotting. - Check tubing system for kinking. - Adapt limits.	Warning message sent to TLC.
Repeat self test! (Code 1153)	- Yellow message box in the right corner of the display	LLC has finished self tests but LLS not (based on communication LLS->LLC)	- If warning persists call technician.	Warning message sent to TLC.
+/- 12 V test not ok (Code 1155)	- Yellow message box in the right corner of the display	Self test failed	- If warning persists call technician.	Warning message sent to TLC. Self test repetition.

Alarm/message/code	Machine Alert	Cause of Alarm	User Action	Machine reaction
LLC Warnings				
Blood leak test not ok (Code 1156)	- Yellow message box in the right corner of the display	Self test failed	- If warning persists, call technician.	Warning message sent to TLC. Self test repetition.
DF pressure test will be repeated (Code 1157)	- Yellow message box in the right corner of the display	Self test failed	- If warning persists, call technician.	Warning message sent to TLC. Self test repetition.
UF pump test will be repeated (Code 1158)	- Yellow message box in the right corner of the display	Self test failed	- If warning persists, call technician.	Warning message sent to TLC. Self test repetition.
Conductivity test not ok (Code 1159)	- Yellow message box in the right corner of the display	Self test failed	- If warning persists, call technician.	Warning message sent to TLC. Self test repetition.
Temperature test not ok (Code 1160)	- Yellow message box in the right corner of the display	Self test failed	- If warning persists, call technician.	Warning message sent to TLC. Self test repetition.
S.A.D. (Ref.) test not ok (Code 1161)	- Yellow message box in the right corner of the display	Self test failed	- If warning persists, call technician.	Warning message sent to TLC. Self test repetition.
S.A.D. (Freq.) test not ok (Code 1162)	- Yellow message box in the right corner of the display	Self test failed	- If warning persists, call technician.	Warning message sent to TLC. Self test repetition.
Blood side pressure sensor test not ok (Code 1163)	- Yellow message box in the right corner of the display	Self test failed	- If warning persists, call technician.	Warning message sent to TLC. Self test repetition.
VBICP test not ok (Code 1164)	- Yellow message box in the right corner of the display - 1x acoustic warning tone	Self test failed	- If warning persists, call technician.	Warning message sent to TLC. Self test repetition.
Self test VD failed (Code 1165)	- Yellow message box in the right corner of the display	Self test failed	- If warning persists, call technician.	Warning message sent to TLC. Self test repetition.
Sound + LED Test failed (Code 1167)	- Yellow message box in the right corner of the display	Self test failed	- If warning persists, call technician.	Warning message sent to TLC. Self test repetition.
Blood side leakage test not ok (Code 1169)	- Yellow message box in the right corner of the display	Self test failed	- If warning persists, call technician.	Warning message sent to TLC. Self test repetition.

Alarm/Messages/Code	Machine Alert	Cause of Alarm	User Action	Machine reaction
Crit-Line alarms				
HCT is over limit (Dialog) (Code 930)	- Acoustic alarm - Red light	UF rate or volume too high Limit at the Dialog too low	- Reduce UF rate or volume. - Adapt limit at the Dialog.	Alarm message sent to TLC.
HCT reading failed (Code 931)	- Acoustic alarm - Red light	Crit-Line device is switched off Connection disturbed Technical defect	- Check Crit-Line device and connection to Dialog. - Call technician if necessary.	Alarm message sent to TLC. HCT, delta BV and SAT reading cleared in Crit-Line parameter window.
SAT is under limit (Code 935)	- Acoustic alarm - Red light	Patient O ₂ undersupply limit is too high	- Call doctor. - Adapt limit.	Alarm message sent to TLC.

Alarm/Messages/Code	Machine Alert	Cause of Alarm	User Action	Machine reaction
Crit-Line warnings				
No blood detected in Crit-Line (Code 932)	- Yellow message box in the right corner of the display	Sensor not placed correctly at blood chamber.	- Check sensor and blood chamber. - Call technician if necessary.	Warning message sent to TLC.
Sensor obstruction in Crit-Line (Code 933)	- Yellow message box in the right corner of the display	Foreign material/dirt between sensor and blood chamber.	- Check/clean sensor or remove material. - Call technician if necessary.	Warning message sent to TLC.
HCT is over limit (Dialog) (Code 940)	- Yellow message box in the right corner of the display	UF rate or volume too high. Limit at the Dialog too low.	- Reduce UF rate or volume. - Adapt limit at the Dialog.	Warning message sent to TLC.
HCT reading failed (Code 941)	- Yellow message box in the right corner of the display	Crit-Line device is switched off. Connection disturbed. Technical defect.	- Check Crit-Line device and connection to Dialog. - Call technician if necessary.	Warning message sent to TLC.
Crit-Line communication failed (code 942)	- Yellow message box in the right corner of the display	Crit-Line not switched on. Connection disturbed. Technical defect.	- Check Crit-Line device and connection to Dialog. - Call technician if necessary.	Warning message sent to TLC. Status message: "CL no connection" Re-initialization of CL channel.
Please initiate Crit-Line monitor! (code 943)	- Yellow message box in the right corner of the display	Crit-Line measurement not started.	- Start Crit-Line measurement.	Warning message sent to TLC.
HCT is over limit (Crit-Line) (Code 944)	- Yellow message box in the right corner of the display	UF rate or volume too high. Limit at the Crit-Line monitor too low.	- Reduce UF rate or volume. - Adapt limit at Crit-Line monitor.	Warning message sent to TLC.
Set/check HCT limit! (Code 945)	- Yellow message box in the right corner of the display	HCT limit not set or default not confirmed.	- Set value or confirm.	Warning message sent to TLC.
SAT is under limit (Code 946)	- Yellow message box in the right corner of the display	Patient O ₂ undersupply limit is too high.	- Call doctor. - Adapt limit.	Warning message sent to TLC.

Alarm/message/code	Machine Alert	Cause of Alarm	User Action	Machine reaction
Level regulation alarms				
Volume limit level regulation (Code 1011)	- Acoustic alarm - Red light	Max. blood volume exceeds 190 mL	- Check for tubing leakages.	Blood pump stopped. Safety clamp closed. Heparin pump stopped. Level regulation stopped. Bypass.
Timeout level regulation (Code 1024)	- Acoustic alarm - Red light	Level regulation period is limited to 3 minutes	- Set level in less than 3 minutes.	Blood pump stopped. Safety clamp closed. Heparin pump stopped. Level regulation stopped. Bypass.
Blood pump is running (Code 2028)	- Acoustic alarm - Red light	Blood pump must not run in Emptying Dialyzer or when SAD-alarm-resolving is active	- Stop blood pump.	Blood pump stopped. Safety clamp closed. Heparin pump stopped. Level regulation stopped. Bypass.
Volume limit level regulation (Code 2039)	- Acoustic alarm - Red light	Max. blood volume exceeds 220 mL	- Check for tubing leakages.	Blood pump stopped. Safety clamp closed. Heparin pump stopped. Level regulation stopped. Bypass.
Arterial pressure monitoring error (Code 2041)	- Acoustic alarm - Red light	Insufficient arterial pressure pulsation	- Set levels correctly. - Ensure that hydrophobic filters are fluid free.	Blood pump stopped. Heparin pump stopped. Level regulation stopped. Bypass.
Valve position level regulation (Code 2042)	- Acoustic alarm - Red light	Wrong valve position	- Contact technician.	Blood pump stopped. Safety clamp closed Heparin pump stopped. Level regulation stopped. Bypass.
Venous pressure monitoring error (Code 2043)	- Acoustic alarm - Red light	Insufficient venous pressure pulsation	- Set levels correctly.	Blood pump stopped. Heparin pump stopped. Level regulation stopped. Bypass.
PBE pressure monitoring error (Code 2044)	- Acoustic alarm - Red light	Insufficient PBE pressure pulsation	- Set levels correctly. - Ensure that hydrophobic filters are fluid-free.	Blood pump stopped. Heparin pump stopped. Level regulation stopped. Bypass.
PBS pressure monitoring error (Code 2045)	- Acoustic alarm - Red light	Insufficient PBS pressure pulsation	- Ensure that hydrophobic filters are fluid-free.	Blood pump stopped. Heparin pump stopped. Level regulation stopped. Bypass.

13.3 Remediating SAD alarms when using standard A/V tubing systems



In case of air in the area of the SAD, the tube clamp (SAKV) is closed due to the alarm action. Due to the reaction time of the system, a small amount of air may also be below the SAD.



- For removing the air, a note is displayed on the screen.
- Check that all connections are tight.
- If the alarm was triggered by micro foam, it is sufficient to reset the alarm. The reset deletes the alarm not before 2 seconds after switching off the alarm tone. The measuring region of the SAD must now be free of air bubbles.

Removing air bubbles (if level regulation system is present)

If air bubbles in the venous blood line have triggered the alarm, these bubbles must be removed as follows:

- Clamp tube between venous bubble catcher and dialyzer.
- Press Enter key ↵ on the monitor to open the window "increase venous level".
- To increase the venous level press the "increase venous level" icon.
- When the air has been removed, open clamp between venous bubble catcher and dialyzer and press the key "Reset alarm".

Removing air bubbles (if Streamline® bloodlines are used)

If air bubbles in the venous blood line have triggered the alarm, these bubbles must be removed as follows:

- Clamp tube between venous pressure POD and venous end of dialyzer.
- With 20cc syringe apply vacuum of min -75 mmHg at the venous bubble catcher.
- Press Enter key ↵, open venous clamp briefly.
- When the air has been removed, open clamp and press the key "Reset alarm".
- Possibly repeat procedure.

Removing air bubbles (if level regulation system is not present)

For use of standard A/V.

If air bubbles in the venous blood line have triggered the alarm, these bubbles must be removed as follows:

- Clamp tube between venous bubble trap and dialyzer.
This prevents blood from being sucked from the dialyzer.
- Using a syringe, create a vacuum of at least -75mmHg at the venous air bubble trap, see venous pressure display.
As the air is located in the region of the patient inlet, it must be moved back to the venous bubble trap by this vacuum action.
- Press Enter key ↵ on the monitor.
Venous clamp opens briefly.
Blood flows back from the patient inlet and the air is moved into the venous bubble trap.
- Remove clamp between venous bubble trap and dialyzer.

- Once the air has been removed, press the "Reset alarm" button on the monitor. Repeat procedure if necessary.
- Once all air has been removed from the SAD, the alarm is deleted. If some air remains in that region, the process must be repeated.

13.4 Manual blood return



In case of a power failure during dialysis and no emergency power supply is available, the blood must be returned manually to the patient.



Risk to the patient!

- During manual blood return, no air infusion monitoring functions are active in the dialysis machine. Staff must monitor both the patient and the dialysis machine.
- Manual blood return must always be carried out by two persons using the utmost care.
- Always turn blood pump clockwise indicated by arrows on the roller rotor.



The crank for manual blood return may be one of two alternatives (see following pictures).



Fig. 13-2 Use of crank, alternative 1



As shown in Fig. 13-2, insert the crank in the external hole of the blood pump rotor to ease manual rotation.

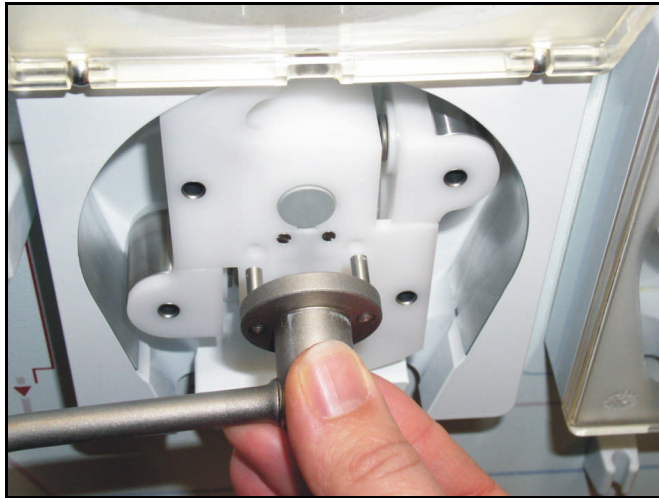

Fig. 13-3 Use of crank, alternative 2

- Remove crank from rear of dialysis machine.
- Open (left, if there are two) blood pump lid and insert crank into the roller rotor.
- Disconnect arterial side from patient, see section 6.1.
- Remove venous blood line from the SAKV.
- Evenly operate the blood pump using the crank. Observe appropriate speed and maintain an adequate blood level in the venous bubble trap.
- Continuously monitor venous patient inlet, which must not contain any air.
- When the physiological saline solution reaches the venous tubing clamp, close the clamp.
- Disconnect the patient on the venous side.

13.5 Muting acoustic signals

13.5.1 Muting acoustic signals for alarms

The sounds can be muted for the following alarms:

ID	Text
600	System recovered

13.5.2 Muting acoustic signals for messages

The sounds can be muted for the following messages:

ID	Text
1900	The selected interval is over
1903	Selected UF volume too high
1904	Selected UF volume too low
1905	Selected UF time too high
1906	Selected UF time too low
1907	Interval cannot be modified
1908	Max. UF ration has profile modified
1911	Selected Heparin rate too high
1912	Selected Heparin rate too low
1922	UF volume has been decreased
1934	Rinsing time too long
1935	Rinsing time too short
1936	UF rinsing volume too high
1937	UF rinsing volume too low
1942	Acknowledge data before connecting patient
2056	No Heparin bolus
2060	Please press longer EQ button again
2066	UF + HDF rate > 5500 mL/h please reduce
2073	Rinsing rate too low
2074	Rinsing rate too high
1093	Pump cover open (substitution)
1054	Preparation of new Bic Cartridge - bypass

Table of contents

14	Accessories and options	14-3
14.1	Accessories and options.....	14-3
14.2	Additional accessories.....	14-4
14.3	Configurations	14-4

14 Accessories and options

14.1 Accessories and options

Name	Article no. (REF)
ABPM: Automatic blood pressure monitoring	7102226
ABPM: Small cuff, latex free	7102372
ABPM: Medium cuff, latex free	7102771
ABPM: Large cuff, latex free	7102380
Blood Pressure Cuff Basket	7102865
Holder for Blood Pressure Cuff	7102781
Battery power supply	7102244
Bicarbonate cartridge holder (BIC)	7105171
Box Comfort	7107302
Multi Functional Tray	7105238
Universal Front Tray	7105239
Flat Combi Tray	7102890
Monitor Mini Shelf	7102872
Record Holder	7102873
Universal Base for Dialog ⁺ Basement (max. 30 kg, e.g. single bed – RO unit)	7105500
Central concentrate supply (ZKV)	7105196
Connection line for electrical ground	8701628
Dialog ⁺ -computer interface (DCI)	7107218
Dialysate fluid filter (DF)	7102102
Dialyzer holder	7107426
Holder for 6 or 10 liter Disinfectant Containers	7102277
DiaLines [®] A/V Bloodtubing	100383
Internal Transducer Protector	34516409
Patient Therapy Card (set with 5 pieces)	7105232
Nexadia (Bed Side Link) BSL	7102230
Sample port dialysate	7102867

WAN BSL (Bed Side Link)	7102231
Adimea™ option UV-Kt/V	7102233
Card reader incl. 5 cards	7105230
Streamline® bloodlines (SL-2010M2096)	on request

14.2 Additional accessories

B. Braun Medical Inc. currently offers accessories from the following product areas:

- Dialyzers
- A/V systems
- Bicarbonate powder cartridges
- Rinsing solutions
- Disinfectants

For further information please contact your B. Braun Medical Inc. representative.

14.3 Configurations

Description	Article no.
Single-pump with ABPM and 120V	710200K
Single-pump with ABPM, BIC and 120V	710200L

Table of contents

15	Technical data.....	15-3
15.1	General technical data.....	15-3
15.2	Ambient conditions	15-4
15.3	Recommended safe distances.....	15-5
15.4	Dialysate system	15-6
15.5	Extracorporeal circulation.....	15-9
15.6	Materials coming into contact with water, dialysate, dialysis concentrates and/or disinfectants	15-11
15.7	ABPM blood pressure monitoring.....	15-12
15.8	Technical data of Crit-Line [®] interface	15-13

15 Technical data

15.1 General technical data

Description	Values
Nominal voltage	120 V~ ± 10 %
Nominal frequency	60 Hz (120 V~)
Nominal current	max. 16 A ± 10 % at 120 V~
Connected load	1.92 kW at 120 V~
Power plug	20 A hospital grade
Current-voltage-rating	20 A, 60 Hz
Minimum cross section of single strand	3.3 mm ² (AWG12)
Withstand voltage of single strand (L-N, L-PN, N-PE)	approx. 2 kV~, 50 Hz, ≥1 min
Average energy consumption	approx. 1.5 kW/h
Heat emission	approx. 230 W/h
Categorization	II b according to EC Directive for Medical Devices 93/42/EEC
Classification	Type B, IEC 60601-1
Device leakage current	< 500 µA~
Patient leakage current	< 10 µA~
Protection class	IP21 (Protection against foreign bodies > 12 mm and vertically falling drip water) DIN EN 60529
Electrical ground	via optional cable
Dimensions (W × H × D)	approx. 510 × 1678 × 637 mm
Housing material	Aluminum, corrosion-proof
Empty weight	approx. 85 kg

Description	Values
Water supply	Water suitable for dialysis
Pressure range	0.5 – 6 bar
Temperature range	10 – 30 °C/50 - 86 °F
Alarm "No water"	from separate monitoring device
Concentrate supply	from container or central supply 0 – 1 bar

For information regarding fuse ratings and battery specifications please refer to service manual.

15.2 Ambient conditions

Description	Values
Operation	
Temperature	+10 to +40 °C/+50 to +104 °F
Relative humidity	15 % – 70 %
Atmospheric pressure	700 – 1060 mbar
Transportation and storage (dry)	
Temperature	-20 to +60 °C/-4 to 140 °F
Relative humidity	15 % – 80 %
Atmospheric pressure	700 – 1060 mbar

15.3 Recommended safe distances

Recommended safe distances in meter (m) between portable or mobile HF telecommunication devices and the Dialog+ dialysis machine			
The dialysis machine Dialog+ is intended for use in ambient conditions with controlled High-Frequency disturbance variables. The user can avoid electromagnetic disturbances by keeping the distance between Dialog+ and HF-telecommunication devices, following the values in the table below, in dependency to the output power of those devices.			
Nominal output P of transmitter (Watt)	Safe distance (d) depending on transmitting frequency		
	150 kHz to 80 MHz $d = 1.2 \sqrt{P}$	80 MHz to 800 MHz $d = 1.2 \sqrt{P}$	800 MHz to 2,5 GHz $d = 2.33 \sqrt{P}$
0.01	0.12	0.12	0.23
0.1	0.38	0.38	0.73
1	1.20	1.20	2.30
10	3.80	3.80	7.30
100	12	12	23

For transmitters with other output power ratings, the recommended safety distance (m) can be calculated with the above formulas. Heed the max. power rating (W), in accordance with the manufacturer's information, and using the correct formula from above.

Remark 1: For 80 MHz and 800 MHz use the higher frequency range.

Remark 2: This guideline may be not practical in some cases. The propagation of electromagnetic forces will be influenced by adsorption and reflexion of the building, equipment and humans.

Find more information about EMC, radio disturbance and IEC 60601-1-2 in the service manual, chapter 8.

15.4 Dialysate system

Description	Values
Temperature setting range	33 – 40 °C/91 - 104 °F
Temperature tolerance at standard ambient temperature	+0.5 °C to -1.5 °C/+33 °F to 29 °F
Limits	±1 °C/34 °F (of set specified value)
Excessive-temperature protection	41 °C/106 °F
Protection system	Temperature sensor
Bridging time of protection system	Cannot be bridged during dialysis
Deactivation of acoustic alarm	120 seconds
Heating power	1800 W
Conditioning	Conductivity regulated
Operating regime	Conductivity bicarbonate 2 – 4 mS/cm, 4 – 7 mS/cm Overall conductivity 12.5 – 16 mS/cm
Tolerance	±0.2 mS/cm
Measurement	Temperature-compensated (reference temperature 25 °C/77 °F)
Protection system	Monitoring through second conductivity sensor with modified geometry
Limit	±5 % (of set value)
Bridging time of protection system	cannot be bridged during dialysis
Deactivation of acoustic alarm	180 seconds
Flow (dialysate)	300 – 800 mL/min
DF tolerance at dialysis machine	±5 % (of specified value) at 300 - 800 mL/min
Bridging time of protection system	Not bridgeable via balance chamber filling times during dialysis
Deactivation of acoustic alarm	300 seconds

Description	Values
Dialysate pressure range area	+400 to -450 mmHg
Tolerance (PDA)	±10 mmHg
Upper limit	+400 mmHg
Lower limit	-450 mmHg
Deactivation of acoustic alarm	120 seconds
Blood leak detector	Red sensor
Tolerance	10 %
Alarm threshold	>0.5 mL/min blood at HKT 45 % >0.35 mL/min blood at HKT 25 % (AAMI)
Bridging time	Not bridgeable during dialysis
Deactivation of acoustic alarm	120 seconds
Ultrafiltration	Volume-controlled via balance chambers, ultrafiltration through ultrafiltration pump Sequential ultrafiltration (Bergström)
Operating range	0 – 4,000 mL/h
Overall accuracy *	$F = F_{bal} + F_{UF}$
F _{bal}	± 0.2 mL/chamber cycle
F _{UF}	Ultrafiltration pump tolerance <1 %
Protection system	Speed monitoring of UF Pump with an accuracy of <1 %; System will alarm 200 mL beyond given value or 10 % beyond preset UF rate.
Bridging time of protection system	Not bridgeable during dialysis
Deactivation of acoustic alarm	120 seconds

*The overall accuracy F is the sum of two different errors:

$$F = F_{bal} + F_{UF}$$

F_{bal} = balance chamber deviation (measures per chamber cycles and depends on the dialysate flow)

F_{UF} = UF pump error

Description	Values
Transmembrane pressure	
Limit range (max. TMP)	300 – 700 mmHg
Absolute alarm limit	-100 mmHg
Limit window	Adjustable (2 % - 99 %)
Tolerance	Calculated through PDA and PV
Bridging time of protection system	Not bridgeable during dialysis
Deactivation of acoustic alarm	120 seconds
Degassing system	Mechanically regulated through the degassing pump
Tolerance	± 50 mmHg
Disinfection During disinfection processes, dialysis is blocked. Reports on the effectiveness of the individual disinfection programs can be obtained from the manufacturer.	
Disinfection/cleaning	Automatic program with enforced rinse-out The parameters for the disinfectant used can be set in the service program. HDF-online and dialysis fluid filter option: Only disinfectants cleared for the dialysis fluid filter can be used.
Thermal disinfection	Automatic program cycle at approx. 85 °C/185 °F at the dialyzer couplings

15.5 Extracorporeal circulation

Description	Values
Blood pump	2-roller pump with automatic motor switch-off when lid is opened, backstop, low hemolysis. For 8/12 mm or (optional) 7/10 mm pump tubes
Pumping rate	50 – 600 mL/min (8/12 mm) 50 – 400 mL/min (7/10 mm) Adjustable in 10 mL steps
Tolerance interval	< 10 % for blood pressure up to -150 mmHg Tolerance between 10 % and 25 % for blood pressure up to -200 mmHg
Working pressure range	Intake pressure up to -390 mmHg Pumping pressure 0 – 1725 mmHg
Heparin pump	Syringe pump for 10 – 30 mL syringes
Pumping rate	0.1 – 10 mL/h in steps of 0.5 mL/h or 0.1 mL/h, could be shut down at bolus: 600 mL/h
Tolerance interval	< ±10 %
Pressure range	0 to +480 mmHg
Safety air detector	SAD, based on ultrasound
Sensitivity	Air bubbles at > 50 µl, micro foam with cumulated volume Limit values double needle: 0.2 mL at 0 – 200 mL/min SAD flow 0.3 mL at 200 – 400 mL/min SAD flow 0.5 mL at > 400 mL/min SAD flow Limit values single needle: 0.7 mL at 1200 mL/min constant SAD flow
Protection system	Ultrasound detector, automatic cyclical checks during entire operating phase
Bridging time of protective system	Not bridgeable during dialysis only in end phase for approx. 30 mL (has to be activated at TSM)
Red sensor	in SAD housing
Function	Detects blood in tubing system
Functions	1st mode of operation: The blood pump is stopped as soon as the red sensor detects blood when connected at this site. → Alarm 2nd mode of operation: If the red sensor detects blood at this point, a heparin bolus is administered. This function can be disabled by technical service in the service program. 3rd mode of operation: If no blood is detected at this site in the End Therapy mode, the blood pump is stopped. 4th mode of operation: If blood is detected during preparation or disinfection, the blood pump is stopped → Alarm

Description	Values
Pressure measurement at arterial inlet of dialyzer (PBE)	Electronic pressure sensor
Operating range	0 – 700 mmHg
Tolerance interval	±10 mmHg
Limit	Adjustable within operating range
Protection system	Test prior to start of therapy
Arterial inlet pressure (PA) measurement	Electronic pressure sensor with digital quasi-analogue display
Operating range	–400 to +400 mmHg
Tolerance	±10 mmHg
Limit	–400 to +400 mmHg adjustable within operating range, adjustable interval width for dynamic limits window
Protection system	Electronic pressure sensor, test prior to start of therapy
Deactivation of acoustic alarm	120 seconds
Venous return pressure (PV) measurement	Electronic pressure sensor with digital quasi-analogue display
Operating range	20 – 390 mmHg (adjustable in service program)
Tolerance	±10 mmHg
Limit	Alarm window around operating value Configurable alarm window (20 – 200 mmHg) After blood pump adjustment, the alarm window is re-centered.
Protection system	Test prior to start of therapy Venous window of 20 – 390 mmHg. Venous limits are monitored by the function and control systems.
Bridging time of protection system	Not bridgeable during dialysis
Deactivation of acoustic alarm	120 seconds

15.6 Materials coming into contact with water, dialysate, dialysis concentrates and/or disinfectants

Material name	Abbreviation if existent
Ceramics	
Ethylene Propylene Diene Monomer	EPDM
Fluoroelastomer	FKM
Glass	
Graphite	
Polyamide	PA
Polyester	
Polyetheretherketone	PEEK
Polyetherimide	PEI
Polyethylene	PE
Polyisoprene	
Polymethylmethacrylate	PMMA
Polyoxymethylene	POM
Polyphenylsulfone	PPSU
Polypropylene	PP
Polypropylene Oxide	PPO
Polytetrafluorethylene	PTFE
Polyurethane	PUR
Polyvinylchloride	PVC
Polyvinylidene difluoride	PVDF
Silicone	
Stainless steel	
Thermoplastic Urethane	TPU

15.7 ABPM blood pressure monitoring

Description	Values
Cuff pressure range	0 – 320 mmHg
Inflation pressure during first cuff inflation	200 mmHg
Inflation pressure during subsequent measurements	Last SYS pressure +30 mmHg
Blood pressure measurement range	Systole 45 – 280 mmHg MAP 25 – 240 mmHg Diastole 15 – 220 mmHg
Accuracy	±3 mmHg or ±2 %
Blood pressure determination time	Typical 25 seconds (Adult with blood pressure 120/80 and 80 BPM)
Pulse rate determination	30 – 240 BPM
Pulse rate accuracy	±2 % or 2 BPM
Overpressure cut-off	300 mmHg + 10 %
Time of alarm suppression	< 1 second
Deactivation of acoustic signal	120 seconds
Defibrillation	Protected applied part
Safety class	Safety class I, Type BF

15.8 Technical data of Crit-Line[®] interface

The intended use of the DSI interface is to connect the Crit-Line III TQA device of Hema Metrics[®] to the Dialog+ or other devices released by B. Braun Medical Inc. for operation.

It is prohibited to connect any other device.

The DSI interface is galvanically isolated from the Dialog+/staff/patient according to the standard IEC 60601-1.

Description	Values
Maximum specific transfer rate	115.2 KBaud
Maximum voltage level (all pins in relation to GND (ground)-level)	$\pm 25 V_{DC}$
Maximum ohmic impedance of external serial connection cable	7 K Ω
Maximum capacitive impedance of external serial connection cable	2500 pF



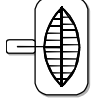





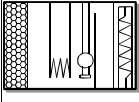

Table of contents





16	Appendix.....	16-3
16.1	Dialysate flow chart	16-3
16.1.1	Key to dialysis flow chart	16-3
16.1.2	Flow chart Dialog ⁺	16-5
16.2	Service protocols	16-6

16 Appendix

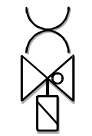
16.1 Dialysate flow chart

16.1.1 Key to dialysis flow chart

Symbol	Abbreviation	Description
	BICLF ENDLF ENDLF-S	Bicarbonate conductivity sensor END conductivity sensor END conductivity sensor supervisor
	BICP BPA BPV	Bicarbonate concentrate pump Arterial blood pump Venous blood pump
	BICSS KSS	Bicarbonate rinsing connection sensor Concentrate rinsing connection sensor
	BK1 MSBK1 BK2 MSBK2	Balance chamber 1 Membrane position sensor balance chamber 1 Balance chamber 2 Membrane position sensor balance chamber 2
	BL	Blood leak detector
	BVA KVA	Bicarbonate supply connection Concentrate supply connection
	DDE RVDA RVFPA RVFPE	Dialyzer inlet check valve Dialysate check valve Flow pump outlet check valve Flow pump inlet check valve
	DMV	Pressure reduction valve
	EP FPE FPA	Degassing pump Inlet flow pump Outlet flow pump
	WA	Water block with integrated upline tank, level sensor, double-stage heater, heat exchanger and degassing chamber
	PA PBE PBS PDA PE PV	Arterial pressure sensor Blood inlet pressure sensor Blood control pressure sensor Dialysate outlet pressure sensor Degassing pressure sensor Venous pressure sensor
	VEB	Degassing bypass valve

Symbol	Abbreviation	Description
	DBK	Bicarbonate cartridge throttle
	VABK1/2, VBE, VBICP, VBKO, VBKS, VBP, VDA, VDABK1/2, VDE, VDEBK1/2, VEBK1/2, VLA, VSAE, VSB, VVB, VVBE, VZ	Solenoid valve
	TSE TSHE TSH TSBIC TSD TSD_S	Degassing temperature sensor Heater inlet temperature sensor Thermal fuse heater Bicarbonate temperature sensor Dialysate temperature sensor Dialysate temperature sensor supervisor
	RVB RVBO RVBU RVK	Bicarbonate check valve Top bicarbonate check valve Bottom bicarbonate check valve Concentrate check valve

16.1.2 Flow chart Dialog+

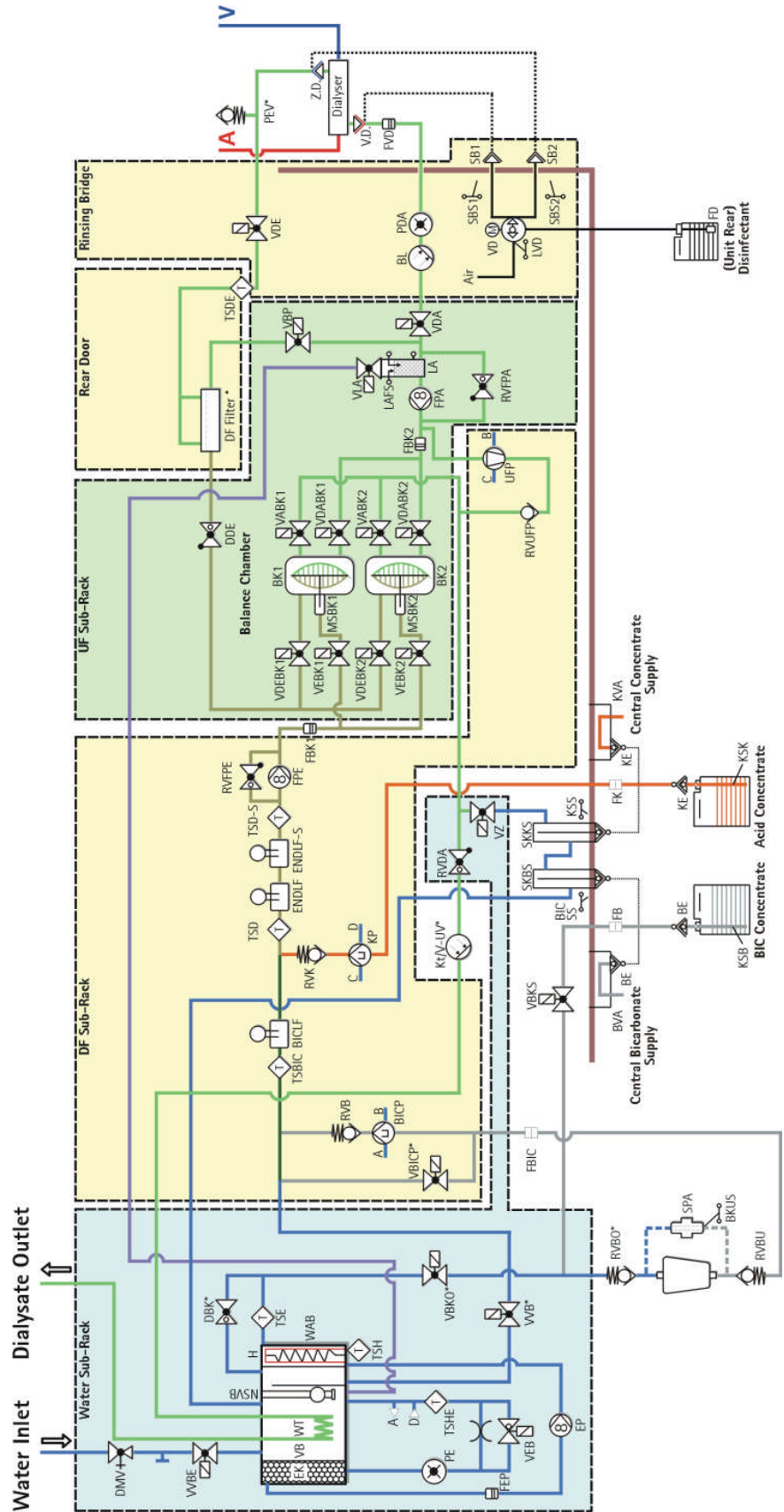

16.2 Service protocols

The relevant checklist is included in the service manual.

Clorox is a registered trademark of The Clorox Company

Crit-Line and Hema Metrics are registered trademarks of Fresenius Medical Care Holdings, Inc.

Locksite and Streamline are registered trademarks of Nxstage Medical, Inc.

